

Introduction

Meaning of building ÷ Building not only gives us shelter and protection but also to serve intended function by providing sufficient accommodation, comfort, ventilation and appearance to the user.

- In civil engineering, building is defined as a structure consisting of various components like foundation, walls, columns, beams, roofs, floors and doors etc. to provide adequate space for specific uses like residential, educational, industrial and business etc.
- Building design and construction is the responsibility of civil engineers and architects.
- All buildings are constructed according to the drawings and specifications which are prepared keeping in mind, the building by laws.
- Every city has its own building by laws to which all the buildings of that area must conform.

Classification of buildings based on occupancy.

NBC of India classifies the buildings into the following nine groups based on occupancy (type of use) of the building.

1. Group A - residential buildings.
2. Group B - educational buildings.
3. Group C - Institutional buildings.
4. Group D - <sup>Assembly</sup> Business buildings.

- 5. Group e - Business buildings.
- 6. Group f - Mercantile buildings.
- 7. Group g - Industrial buildings.
- 8. Group h - Storage buildings.
- 9. Group i - Hazardous buildings.

1. Group A - Residential Buildings.

- As per NBC, Buildings which are used for normal residential purposes are called as residential building.
- It must provide with sleeping accommodation and with or without cooking or dining facilities or both.
- Residential Buildings are further classified in to following sub groups.
  - 1. A-1 - Lodging or rooming house.
  - 2. A-2 - one or two family private dwellings.
  - 3. A-3 - Dormitories.
  - 4. A-4 - Apartment houses.
  - 5. A-5 - Hotels.

2. Group B - Educational Buildings.

Educational buildings are those buildings which are exclusively used for school or college, research, institution, quarters for staff in the premises building used as a hostel whether it is situated in its campus or outside.

3. Group C - Institutional Buildings.

This group includes the buildings constructed by Govt, semi Govt, or Registered trusts and used for medical or other treatment, Auditorium or complex for cultural and allied activities, care of persons suffering from physical or mental illness, handicap disease or infirmity, care of orphans, abandoned women, children and infants, convalescent, aged persons, tharemsahals, hospital, sanatoria, custodial and penal institutions such as jail, prisons, mental hospitals, houses of correction, detention and reformatories etc.

These are divided into following subgroups.

- 1. C-1 - Hospitals and sanatoria (including nursing home).
- 2. C-2 - custodial institutions - orphanages, old age homes.
- 3. C-3 - penal institutions - jails, prisons, mental hospitals and reformatories.

4. Group D - Assembly Buildings.

Where group of people congregate or gather for amusement recreation, social, religious, patriotic civil, travel and similar purposes.

Example - Buildings of drama, cinema halls, theaters, assembly halls, town halls, auditoriums, exhibition halls, museums, gymnasia, restaurants, eating boarding houses, place of worship, dance hall clubs, gymkhanas public transportation stations and recreation places.

### 5. Group E - Business Buildings

Office building (premises) includes a building or premises whose principal use is for an office purposes or electrical work. include the telegraph and computer operation and "electrical work" includes writing, book-keeping, sorting papers, typing, filing, duplicating, punching card of matter for publication and editorial preparation of matter for publication.

### 6. Group F - Mercantile Buildings

Any building or a part of a building which is used as shops, stores, market for display and sale of whole sale or retail goods, merchandise or including office storage and service facilities etc.....

### 7. Group G - Industrial Buildings

Any building or part of a building in which product or material of all kinds and properties are fabricated, assembled or processed.

Example - Assembly plants, gas plants, dairies refineries, mills and industries;

### 8. Group H - Storage Buildings

The buildings which is mainly used for storage or sheltering of goods, except which are highly combustible or explosive materials, vehicles or animals.

Example ÷ 1. Ware houses    2. cold storage    3. transited.  
4. Garages.

### 9. Group I - Hazardous Buildings.

The buildings which are generally used for storing, handling, manufacturing highly combustible explosive material or products which are liable to burn and may produce poisonous smoke or gases or may produce explosive which are very toxic and dangerous for life.

The buildings which come under this group are used for.

- i) storing gases under pressure like ammonia, hydrogen, chlorine, sulphur dioxide and acetylene.
- ii) storing and handling toxic and highly inflammable liquids.  
Example - acids, toxic or noxious alkalies.
- iii) storing and handling toxic and highly inflammable or explosive materials other than liquids.
- iv) Manufacturing explosives, synthetic leather, rubber.

### Expected questions.

- 1- what is the definition of building?
- 2- what are the different component of building?
- 3- what are the classification of building according to NBC or BIS.

• (as per NBC)

## Introduction

Different components of a building.

A building is mainly divided into the following.

- Two main part.
- a) sub-structure.
- b) super structure.

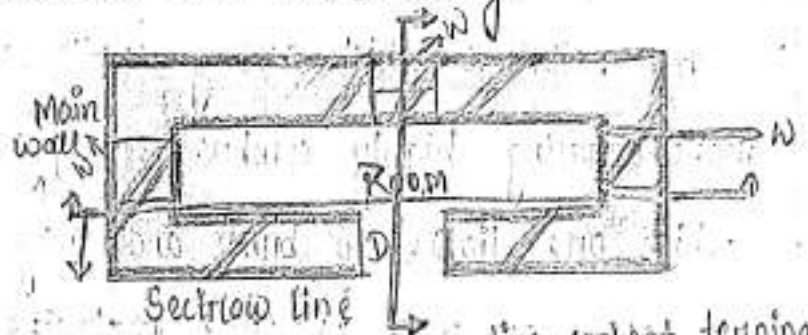

### ⊙ sub-structure:

The part of the building which is below the ground level is called as sub-structure.

Example: foundation.

### ⊙ super structure:

The part of the building above the ground level is called as super structure.

Example: walls and roof.

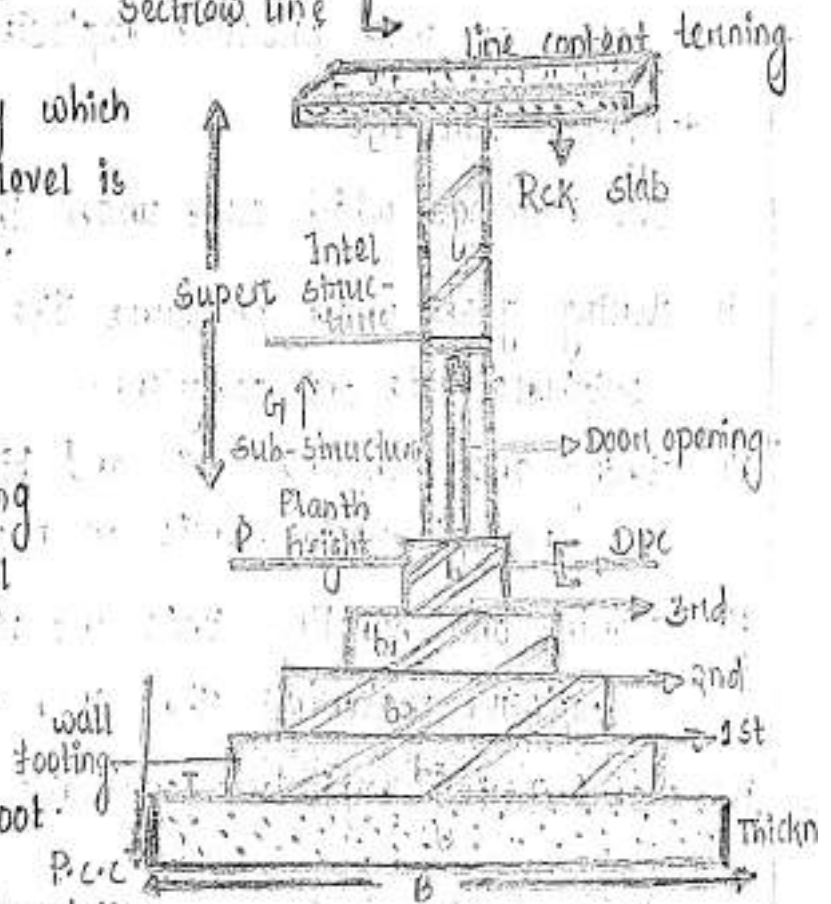

1 - Length with of the foundation

D - Depth of foundation (plain cement concrete)

B - Breadth of foundation (1/3 of a wall foundation)

Following are the main components of a building.

1. Foundation.
2. plinth.
3. walls.
4. columns.

Imp  $D \leq B$

(shallow foundation)

$D > B$

(Deep foundation)

5. Floors.
6. Sills.
7. Doors, window and ventilators.
8. Roofs.
9. Stairs, lifts, ramps.
10. Building finishes.
11. Utility fixtures or services.

1. Foundation - Foundation is the substructure part of the building which is in direct contact with the subsoil. It transmits all the building loads to the sub-soil. It transmits loads in such a way that the subsoil should not fail and the settlement within permissible limit. It depends upon type of building constructed.

Example -

Load Bearing wall - construction process is spread footing.  
 Framed structure - Raft foundation or pile foundation.

2. Plinth - The part of the building between the ground level and top of the floor level, immediately above the ground is known as plinth.

What is plinth height?

It is the height between ground level to plinth level.

Plinth height is 45 cm.

The built up area measure at the plinth level is known as plinth area.

### 3. Walls ÷

1. Walls are constructed to enclose or divide the floor space in desired way and it also gives protection from weather i.e. sun, rain, cold security, privacy.
2. Walls should divide the space in such a way, that minimum carpet area and minimum area of circulation is available.
3. Walls can be made up in bricks, stones or concrete blocks bond together with mortar or of RCC.
4. When bricks are used to make walls it is known as brick masonry and when stones are used then stone.

#### Imp ÷

- Walls are generally divided into two main types.
- i) load bearing walls.
  - ii) Non-load bearing walls.

#### Load Bearing walls ÷

Load bearing walls are those walls which not only support their own weight but also the super imposed loads transferred to them from the floors and roofs.

Example - main walls.

#### Non-load Bearing walls ÷

Non-load bearing walls are those walls which support their own weight only and do not support the super imposed load of the structure.

Example - partition walls.



Column :-

1. It is a vertical compression member which transfer the super imposed load from, the beams of floors/roofs to the foundation.
2. column can be constructed with bricks, RCC, pcc (According to material of construction).
3. According to shapes the columns can be constructed as square, rectangular and circular.

Floors :-

1. Floors divided the building into different levels and floor immediately above the ground level is called as ground floor and floor above it are called as upper floors of 1st, 2nd etc.
2. The floor below the ground level is known as lower ground floor or basement.
3. It should be firm, rigid body and even platform form the occupants of the building and the furniture fixture and equipment.
4. Floor, should provide enough strength and stability to support super imposed load also flooring is a layer provided as per desired specifications for giving suitable floor finish.

Expected questions :-

1. what is foundation?
2. what is plinth or plinth height?
3. what is load bearing and non-load bearing walls with examples?
4. what is column?

### Classification of rock or stone.

Stones are naturally occurring compact, solid, massive materials in the earth technically known as rocks.

The building stones are classified in three ways:

A. Geological classification.

B. Chemical classification.

C. Structurally classification.

### A. Geological classification.

This classification is based on the mode of formation of the rocks; from which the building stone is obtained it is recognized by the geologists, are:

1. Igneous rocks.
2. Sedimentary rocks.
3. Metamorphic rocks.

#### 1. Igneous rocks (Greek, Ignis = Fire):

- All those rocks of the earth formed by the natural process of cooling and crystallization from originally hot and molten materials.
- Hot molten material formed and occurs below the eq<sup>n</sup> known as magma, this magma come out frequently in the form of lava from volcanoes called igneous rocks.
- This rocks further distinguished by geologist into three sub-classes on the basis of their depth of formation:
  - a) plutonic rocks.
  - b) volcanic rocks.
  - c) Hypabyssal rocks.

- a) plutonic rocks :-
1. These are formed at great depths below the surface and can be seen by soil.
  2. These are coarsely crystallized.
  3. These crystals can be easily seen by magnifying glasses.
  4. Example — Gneisses, syenites and gabbros.
- (Igneous plutonic rocks)

- b) Volcanic rocks :-
1. These are formed on the surface of the earth from lava coming out due to volcanoes.
  2. The constituents minerals can be seen by microscopes.
  3. Example — Basalts and trap.

3. Hypabyssals rocks :-
1. These are formed at shallower depth, about 2-3 km below the surface from magma that could not come out as lava.
  2. The crystals are partly coarse and partly fine in size.
  3. Example — porphyries.

2. Sedimentary Rocks :- (Sediment = particle) -

It is found on the surface of the earth by a simple process and breakdown into smaller particles. Under the influence of natural agencies like wind, water, ice and also atmospheric gases.

Some other points about sedimentary rocks are...

- The sediment produce by natural agencies are transported to river bed, lake, basins, sea and oceans where their deposition takes place for year.
- Gradually it forms a hard mass seen these are formed from sediment called as sedimentary rocks.

The sub-groups of sedimentary rocks.

- a) elastic rocks.
- b) chemically formed rocks.
- c) organically formed rocks.

a) elastic rocks - 1. It is wide spread such as sand and shales, breccias, conglomerates.

2. They form good building stone.

b) chemically formed rocks - 1. These type of rocks form from evaporation from river, lake and sea water.

2. Some of the component of previous rocks are taken in solution during the processes of weathering and erosion.

3. The waters may get saturated with these, components with passage of time and precipitate them.

4. Example - lime stones, gypsum, anhydrite, rock salt.

5. It is not a good building stone.

c) Organically formed sedimentary Rocks -

1. Many sea animals have their hard parts made up of bones, which are a mixture of calcium

and magnesium carbonates.

2. These parts accumulate on the sea floors on the death of these animals and gradually huge thickness of such deposits get formed is known as organic formed sedimentary rocks.

3. Example - lime stone ( $\text{CaCO}_3$ ).

4. It is a good building stone.

C) Metamorphic Rocks (Meta = change, Morph = form).

1. These are originally either igneous or sedimentary rocks.

2. The process for their change under the influence of increased temperature, pressure and chemical environment is called metamorphism.

3. This pressure changes the original structure and chemical constitution. After changes new rock is called metamorphic rocks.

4. Example - Marble, slate, shale, quartzite, gneiss and schists.

The nature of change of an original rock into a metamorphic rock depends on the following factors.

i) the type of agents / operating (temperature, pressure, fluids)

ii) the duration of operation of the above agent.

iii) the nature and composition of the original rocks.

# Geological Classification

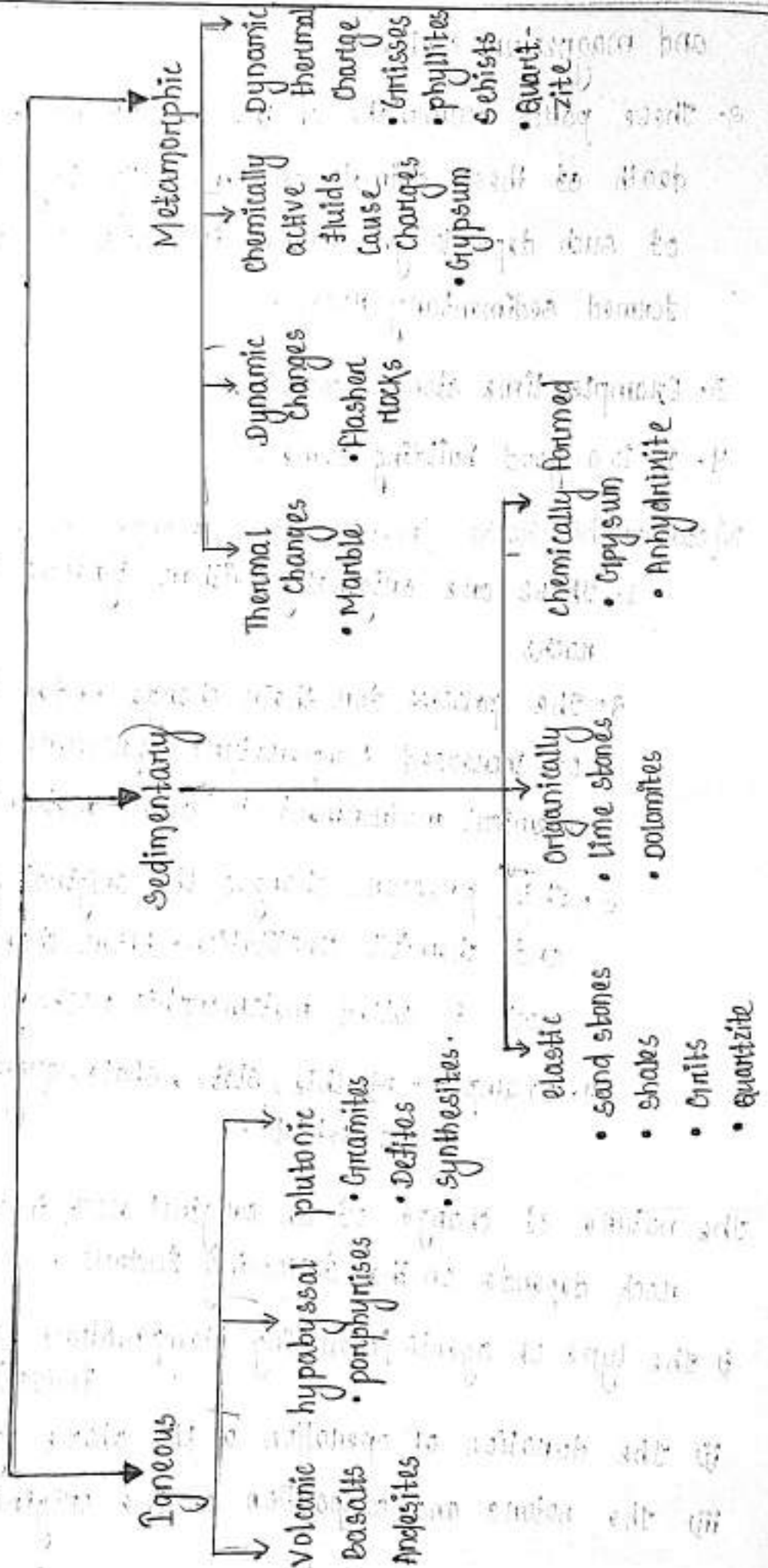

## Chemical classification :-

On the basis of dominant chemical composition.

The following three main groups of rocks (stones) are commonly recognized :

### 1. Silicious rocks.

- These rocks have SILICA ( $SiO_2$ ) as the predominant component, and more than 50% of the bulk composition of the rock.
- Some sedimentary and metamorphic rocks are entirely made up of silica and includes varieties of quartzites.
- It is the strongest building stone.
- Some other rocks granites, sand stones and gneisses made up predominantly silica in combined forms.

### 2. Calcareous rocks.

- In these rocks the dominant component is a carbonate of calcium and magnesium.
- They belong to sedimentary and metamorphic groups of rocks.
- Example - limestone, dolomite and marble and all these are carbonate rocks.
- These above rocks are good building stones.

### 3. Argillaceous rocks.

- These rocks belongs to sedimentary and metamorphic groups of rocks.
- These rocks are soft and not a good variety of building stone.
- Example - shales slates and schists.

Table - chemical classification of rocks.

SILICEOUS $SiO_2 > 50\%$	CALCREOUS $CO_3 > 50\%$	ARGILLACEOUS Clays $> 50\%$
Examples: Granites (Ign) Quartzites (sed/meta) Gneisses (Meta)	Examples: Lime stones (sed) Dolomites (sed) Marbles (Meta)	Examples: Clay stones (sed) Siltstones (sed) Slatos (Meta)

## C. Structural (physical) classification.

- The massive or unstratified rocks.
- These occur in huge masses without showing any layered structure.
- Igneous and metamorphic rocks and some sedimentary rocks may be seen occurring as big masses.
- Example: Granites and quartzites.

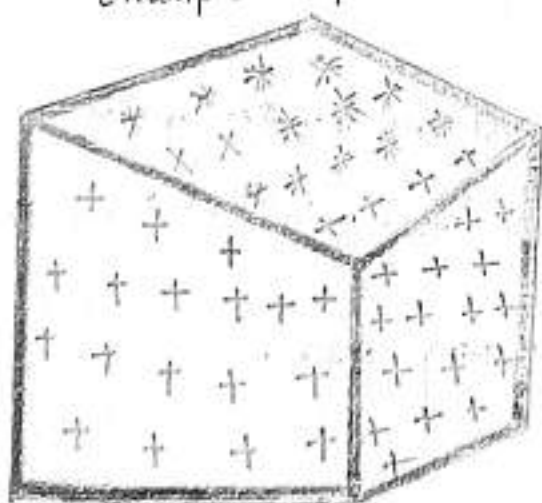

(a) Massive and

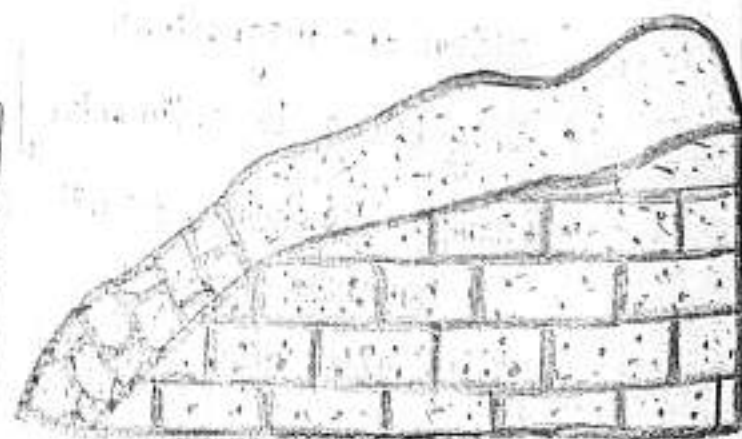

(b) stratified rocks.



## 2. The stratified Rocks.

- Most sedimentary rocks occurs in distinct layers of same or different colour and composition.
- The different layers are also called beds and are separated by planes of weakness called bedding planes.

## 3. The foliated Rocks.

- These type of rocks develop well defined bands of different composition.
- Example schists and gneisses.
- Sometimes well-defined layers are induced under pressure, as in slates.
- It is not a good quality of building stone.

## Construction Technology.

18

consumption of water / cum for cement concrete construction.

$M_{10} = 1:3:6$  [ example  
100 gm cement, 300 gm sand, 60 gm

which means Mix 10 i.e. characteristics compressive strength (Compression testing machine) at 28 days is  $10 \text{ N/mm}^2$  coarse aggregate

$M_{10}$  = Grade of concrete (p.c.c.) .

For 1 cum of cement concrete work requires = 33 litre of

$M_{15} = 1:2:4 = 27$  liter of water .

$M_{20} = 1:1\frac{1}{2}:3 = 23$  liter of water .

$M_{25} = 1:4:8$  (lean concrete) = ordinary construction .

$M_{30} = 1:1:2$  (design mix concrete) = 18 litres of water .

### Expected questions for exam.

1. what are the factors which causes settlement of foundation?

answer. There are four factors responsible for settlement of foundation also collapse the entire structure .

- Load intensity of superstructure and stress induced in soil .
- Quality of soil .
- Depth of foundation or depth below the surface level .
- Intensity of soil reaction in all the components of structure .

2. what is sub-grade or base of foundation?

Answer:

The ground on which the foundation rest is called subgrade or base of foundation.

Objects of foundation.

Foundations are provided for the following purposes.

- To distribute the total load coming on the structure on a larger area so as to bring down the intensity of load at its base below the safe bearing capacity of sub soil.
- To support the structure.
- To give enough lateral stability to the structures against various disturbing horizontal forces such as wind, rain, earthquake.
- To prepare a level and hard surface for concreting and masonry work.
- To transmit the super-imposed loads through side friction and end bearing in case of deep foundation.
- To distribute the non-uniform load of the superstructure evenly to the subsoil.
- To provide the structure safety against undermining or scouring due to animals and flood water.
- To prevent or minimise cracks due to movement of moisture in case of weak or poor soils.

Expected Q:

1. What are the objects or objective or purpose of foundation?

## Natural Bed of stone.

- A stratified or layered rocks show different strength values when loaded perpendicular to bedding and parallel to bedding.
- Its compressive strength of the stone is always greater in the first case where the stone offers maximum resistance.
- When the load is applied parallel to the layers or beds, there is tendency to failure by slipping along the bedding planes.
- The property of natural bedding has to be kept in mind while placing the stone in a particular location in the building. Take two situations:
  - In the walls, the load acts vertically downwards hence the stone should be placed with the natural bed in a horizontal position (a) and not in a parallel position as shown in (b).
  - In the arches, the load acts transverse (arch action). Hence the stone must be placed with the natural bed vertical or inclined so that it is almost at right angles to direction of resultant forces.

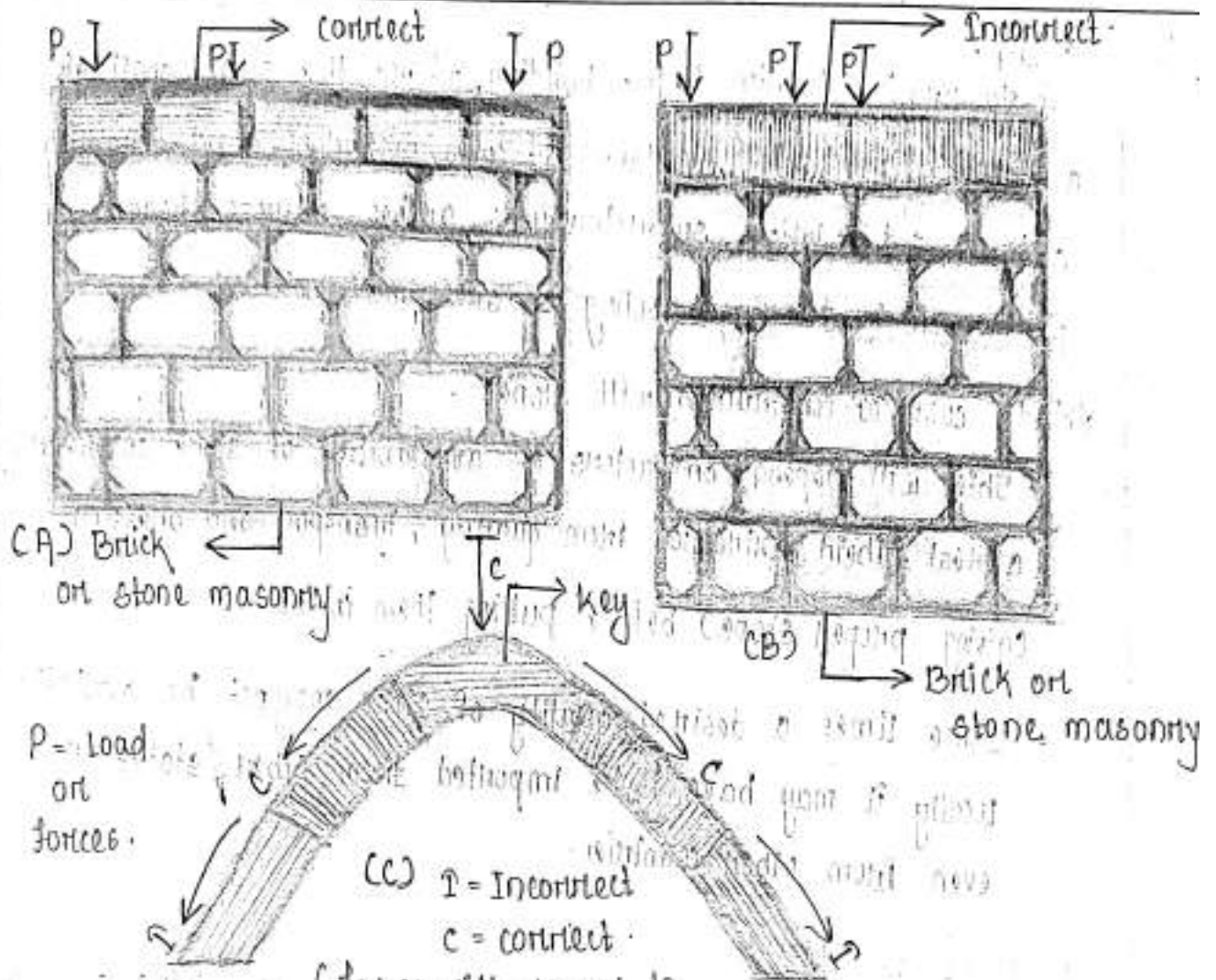

Uses of stone

(forces with respect to natural bed)

Three factors are generally considered by an engineer while deciding the use of a stone in the construction jobs:

First. The type of building and the situation where he wants to use the stone such as:

- i) A residential building or a public building; such as school, departmental office, community centre.
- ii) A commercial building like a cinema hall, shopping complex stadium.
- iii) A monumental building such as a temple, mosque, church and fort.

Second.

To precise location in the building where the stone shall give a preferential benefit in terms of cost, appearance and durability such as in foundations, superstructures, arches, columns, beams, plinths or in flooring, roofing or sills and cantilevers.

Third. cost of construction with stones.

- This will depend on factors of availability of stone in nearby a deal, their extraction from quarry, transport and dressing (giving proper shape) before putting them in use.
- some times a desired quality of stone may not be available locally it may have to be imported from other states or even from other countries.

Dressing of stones.

Definition ÷ Dressing of stone is the process of giving a proper size, shape and finish to the roughly broken stones as obtained from the quarry. This is done either manually or mechanically or in some cases using both the methods.

Objects. Stones as obtained from the quarries are very rough and irregular in shape. Besides, they must be too bulky to be used in construction. The various objectives of dressing are:

Method of stone dressing.

1. Manually.
2. Mechanically.

Tools used in the dressing of stones ÷

1. Drafting chisel.
2. Masons hammer.
3. plane chisel.
4. scabbling hammer.
5. punch chisel.
6. pointed chisel.
7. club hammer.



Drafting chisel.

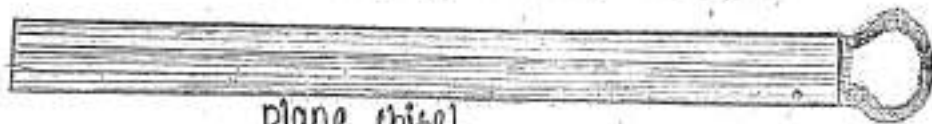

plane chisel



pointed chisel



punch chisel



Masons Hammer

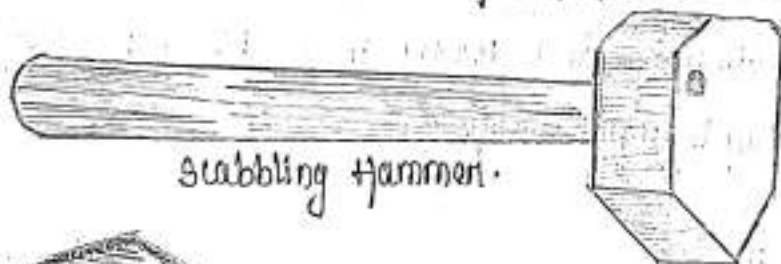

scabbling hammer.



club Hammer.

## Building materials.

24

### Qualities required in stones.

1. Strength

2. Hardness

3. Water absorption.

4. Appearance

5. Workability.

6. Durability.

For ensuring, a durable, cost effective and aesthetically appealing construction, the following properties are deemed desirable in the stones available for selection.

#### 1. Strength.

- For construction normally any stone or brick should sufficient strength to bear usual loads.
- The engineer must satisfy himself about all the strength parameters only after through testing in a accordance with presented codes.

i) compressive strength - It is the main quality of a building stone and may be defined as the maximum load per unit area at which the stone starts breaking.

ii) compressive strength property can be easily tested with a CUMM in laboratory selected stone or brick sample (in cube or cylinder shape) of specified dimension and loaded in machine. The sample is obtained from simple relationship.

$$p = \frac{P}{A}$$

$p$  = stress     $P$  = load     $A$  = Area of cross section.

iii) compressive strength of stones vary from 280 - 2800 kg/cm<sup>2</sup>.  
For bricks it is (A class - 140 kg/cm<sup>2</sup>)



for concrete it is  $280 \text{ kg/cm}^2$ .

## 2. Transverse strength.

- i) It is the resistance a stone (or any other material) offers to bending under load when a stone is required for use as a beam on a lintel.
- ii) This property is commonly determined as modulus of rupture "R" method.
- iii) The 'R' values for different stones vary between  $40 - 300 \text{ kg/cm}^2$ .

## 1. Shear strength.

- i) The stone should withstand shearing types of loads and shearing strength.
- ii) The shearing strength of commonly building stones lies between  $70 - 160 \text{ kg/cm}^2$ .

## 2. Hardness

- i) Hardness of a stone may be defined as its capacity to resist scratching or abrasion.
- Samples of two building stones may have same compressive strength but their hardness must be different.
- If you will take two stones, lime stones and quartzite you will see limestone can be scratched easily with a knife but it is not possible to make an impression with knife on a granite stone.
- The hardness of stones depends on their mineral composition like silicates, oxides, sulphate, sulphide, carbonates etc.

- Hardness is its resistance to wear and tear during its use in situation where rubbing action due to natural agencies (wind and water) or by artificial causes, such as in flooring slabs is taken.

#### iv Toughness.

- It relates to both of hardness and strength.
- It is defined as the capacity of a stone used to withstand the impact loads.
- It is more important when the stones are used in industrial buildings to construct foundation of machine where vibrations may be a common matter.
- In machine foundation it should be a common hard and tough also.

#### 3. Water Absorption.

- Building stones are liable to contact with water when used in foundation and exterior walls.
- The walls must not absorb moisture.
- It is defined as the quantity of water absorbed (in percentage by weight) by a stone till saturation.
- Absorption value of 10% means that a stone on saturation can hold 10% water by weight.

#### Example

A 10 kg block of stone will be having within its body about 1 litre of water.

### Appearance

- stones are available in almost all colours from milk to blood red pitch black.
- Appearance of a stone for use in building becomes an important factor for selection.
- Example :
  - i) Tajmahal of Agra - white marbles.
  - ii) Redfort in Delhi - Red colour sandstone.
- Marble may be red, green, pink and grey colour. sandstone also available.

### Workability

- stones when obtained from their natural places are quite irregular masses and they should be converted to appropriate shapes for use in construction.
- The process of giving a proper shape dimensions and surface finish to a raw stone before it is fit for use in construction is called dressing.

### Example

- i) Igneous rocks - Basalts, traps, granites - Difficult to dress and polish. (They are very hard and tough).
- ii) Metamorphic rocks - Marbles.
- iii) Sedimentary rocks - limestones.
 

{ can be dress-polish due to soft in nature with }  
low cost.

### Durability

- If a stone is durable it must
  - i) withstand loads imposed on it for the entire period of use.
  - ii) Must keep up original appearance even when used in exteriors.

- iii) Must resist the effects of heat and cold.
- iv) Must not suffer deterioration and decomposition by gases, effluent and vapour from surrounding industrial towns.

Characteristics of different types of stones and their uses :-

- Granite -
- It is a coarse to medium grained igneous rock made up essentially of feldspar, orthoclase and quartz minerals.
  - It also contains mineral and mica, hornblende and tourmaline.
  - It is light colour and often spotted.
  - It posses excellent building properties such as high strength values and very hardness, excess duration and very low absorption value.
  - Granites occur in appealing colours and have a capacity to take very fine, glassy, mirror like finish on polishing.
  - It has poor fire resistance.

- Occurance -
- |                    |                      |
|--------------------|----------------------|
| 1. Andhra pradesh. | 4. Kashmir.          |
| 2. Karnataka.      | 5. Himachal pradesh. |
| 3. Kerala.         |                      |

- Basalts -
- It is a volcanic type of igneous rock that is formed from cooling of lava coming out of volcanoes.
  - The basalts also called traps and their mineral composition are the feldspar and ferromagnesian components like hornblende and augite.

- Basalts are dark coloured, fine textured crystalline rocks. They sometimes show cavities and pores developed during cooling process because of escape of gases.
- It is very high strength and resistance to weathering dressing is difficult due to hardness.

Occurrence

1. Mostly south India.
2. Many parts of Maharashtra, and Gujarat.

### Limestones

1. Limestones are fine textured sedimentary rocks of calcareous composition and they occur in stratified formations and also as masses.
- They are made up of calcium carbonate and some varieties also contains magnesium carbonate.
- Dolomite rocks which is made up of magnesium carbonate has some properties as limestones.
- Limestone available variety of colour, like white, grey, black.
- Those limestone which are dense, compact, and massive can be used for building construction.
- It cannot used for industry building in facing portion of construction because toxic gases react with limestone destroy its look and durability.

Occurrence

1. Andhra pradesh.	5. Uttarpradesh.
2. Delhi.	6. Jammu and Kashmir.
3. Madhya pradesh.	7. Rajasthan.
4. Uttaranchal.	

Marble

- Marble is a metamorphic rock of granular (sugar like) texture and calcareous composition.
- It is formed in nature from limestone through the process of metamorphism.
- The essential mineral in marble is calcite (Calcium carbonate  $CaCO_3$ ).
- Marble occurs in a variety of colours from pure white, red, pink, green to dense black.
- It is strong, uniform in texture, least porous and take excellent polish.
- It is suitable both as ornamental stones and for general construction.
- It occurs in the state of Rajasthan at Jodhpur, Jaipur and Ajmer and Baramulla district of Jammu and Kashmir.
- Makrana in Jodhpur - pink and white marbles and Ajmer - Green and yellow marbles.

Sandstones

- It is sedimentary group of rocks, siliceous in composition mostly stratified in structure showing texture variable from coarse to medium to fine grained.
- The essential mineral of sand stone is Quartz ( $SiO_2$ ).
- In cemented variety of sandstone, the cementing material may be siliceous, calcareous or clay in nature can be used for building materials.
- Sand stone show variety of texture ranging from coarse grained, medium grained to fine grained.

- Sandstone occur in many colour, white, grey, pink and maroon and dark.
- It occur in madhyapradesh, uttarpradesh, orissa, Bihar and Jammu & Kashmir.
- Vindhyan sand stones of madhyapradesh - It is suitable, for building and architectural work.

### Gneises

- It is metamorphic group of rocks and generally silicious in composition foliated or banded in structure.
- The mineral present in rocks are feldspar, quartz and ferromagnesium minerals.
- It is a crystalline rock and used as a building stone.
- It occurs in Andhrapradesh, Karnataka, Tamil Nadu and orissa, Bengal, Bihar. (particular in southern states).

### Laterite

- It is a sedimentary group of rock mostly of oxides of aluminium and oxides of iron are present.
- It creates spongy structure and porous texture.
- It occurs in maharashtra, madhyapradesh, Bihar, orissa and southern states (Andhrapradesh, kerela, madras).

### Slate

- It is a metamorphic group of rock with a distinct foliated structure silicious composition and fine textured rock.
- It is impervious and very suitable as roofing stone.
- It is found in Rajasthan, Haryana, Himachal pradesh, Andhra-pradesh, madhyapradesh.
- It is mainly found many parts of Rajasthan.

# Building Materials.

23

## Bricks

Clay (Brick earth and its composition).

- clay is a naturally occurring material that is formed almost evenly where on the surface of the earth making the soil cover on the soft ground. It constitute rock particle by nature agencies such as wind, water, ice and atmosphere.
- It compose of one or more minerals of clay group such as kaolinite, montmorillonite, illite, vermiculate and allophane etc. kaolinite is the most important mineral component of common clays.
- clays occur universally and man has used them since ancient times for making earthenware of great variety.

## Brick Making

The process of manufacturing of bricks is carried out in a number of stages it is essentially a sequential process, next stage is reached only when the previous stage has been completed in all respects. These stages are listed below.

1. selection of suitable type of clay (brick earth).
2. preparation and tempering of mud.
3. Moulding of bricks units.
4. loading of the dried bricks in kilns.
5. Drying of moulding bricks.
6. Firing or burning of dried bricks.
7. cooling of the units.
8. unloading of the kiln.



### Selection of suitable Brick Earth

Good type of bricks cannot be made from every type of clay. A suitable brick earth should have the following composition in the desired proportions.

1. Alumina (20-30%)
2. Silica (50-60%)
3. Iron oxides (4-6%)
4. Lime (4-6%)

#### Alumina

- When alumina is higher than 30%, the brick will become more plastic and also shrink more on drying and develop cracks in the moulded bricks on drying. But if the alumina is present in lesser than 20%, the clay may be difficult to mould proper shapes.

#### Silica

- When present in ideal proportions, i.e. 50-60%, silica imparts the qualities of hardness and strength to the brick. It also resists against shrinking and durability of the brick to weather. When the proportions of silica is more than 60% they will not be mouldable easily. Such bricks when burnt would be quite brittle and porous and also not burnt easily.

#### Iron oxide

- This oxide acts as a flux i.e. it lowers down the softening temperature of silica and other clay components during firing.
- It gives red colour to the burnt bricks.
- Excess iron oxide makes the bricks too soft during the burning stage, deformation in shapes and size and creates darker shade which is not an appealing colour.

- A deficiency of ironoxide in the clays may make their burning difficult and also give them a yellowish appearance.

### Lime

- Lime present in clay help burning and hardening of the bricks quicker and more than 4% causes excessive softening of the clays on heating.
- It must be present in powdered state otherwise when lime is present as nodules it may give rise to slaking. when the brick comes in contact with moisture after its use.

### Slaking

- It is a harmful reaction and may cause slow disintegration of the brick.

### Undesirable components in clay

1. Lime nodules
2. organic matter
3. sulphides and sulphates
4. Alkalies salts

The clay should free from the above components.

### Stage-2 preparation of mud

#### winning

- The process of obtaining brick earth from its natural deposit is called winning.
- The brick earth deposit is first cleared off from vegetation, pebbles and other organic matter.
- Manual digging or mechanical excavation methods are used to obtain dry soil or brick earth. such clay spread on even ground for seasoning.

- It is at this stage that the earth is further cleaned off any pebbles, stones, lime nodules and visible organic matter.
- If needed, any additional quantity of sand and lime are thoroughly mixed with the soil.
- The seasoned clay is ready for making mud by mixing adequate quantities of water.

### Tempering

- It is the process of converting the brick earth to mud of proper consistency by thoroughly mixed with desired quantities of water.
- It is done either by manual labour or with the help of a mechanical called pugmill.

### Manual labour

In manual tempering the clay is spread on a platform and thoroughly kneaded under feet of either men or cattle and water is added in small quantities till desired homogeneity and plasticity are obtained.

### Pug mill Tempering

- The process is sometimes called pugging and is done by mechanical device called pugmill.
- It consists of a steel cylinder covered at the top or near the bottom.
- It is 2 to 3 meter height, a part being below the ground.
- The top diameter of the pugmill is slightly bigger (1m) than the diameter at the base (0.7m).

- A vertical shaft pivoted at the base, which can be rotated with the help of a long arm through animal or motor power.
- The central shaft is attached with horizontal blades each carrying some knives.
- Seasoned clay and water are added from an opening provided at the top.
- The required quantity of clay and water are fed into the pugmill the shaft is made to rotate.
- This action provides the desired churning effect to the clay-water mixture that is converted after some time into mud of desired plasticity and consistency.
- The mud is then taken out from the hole at the base and new charge is filled.

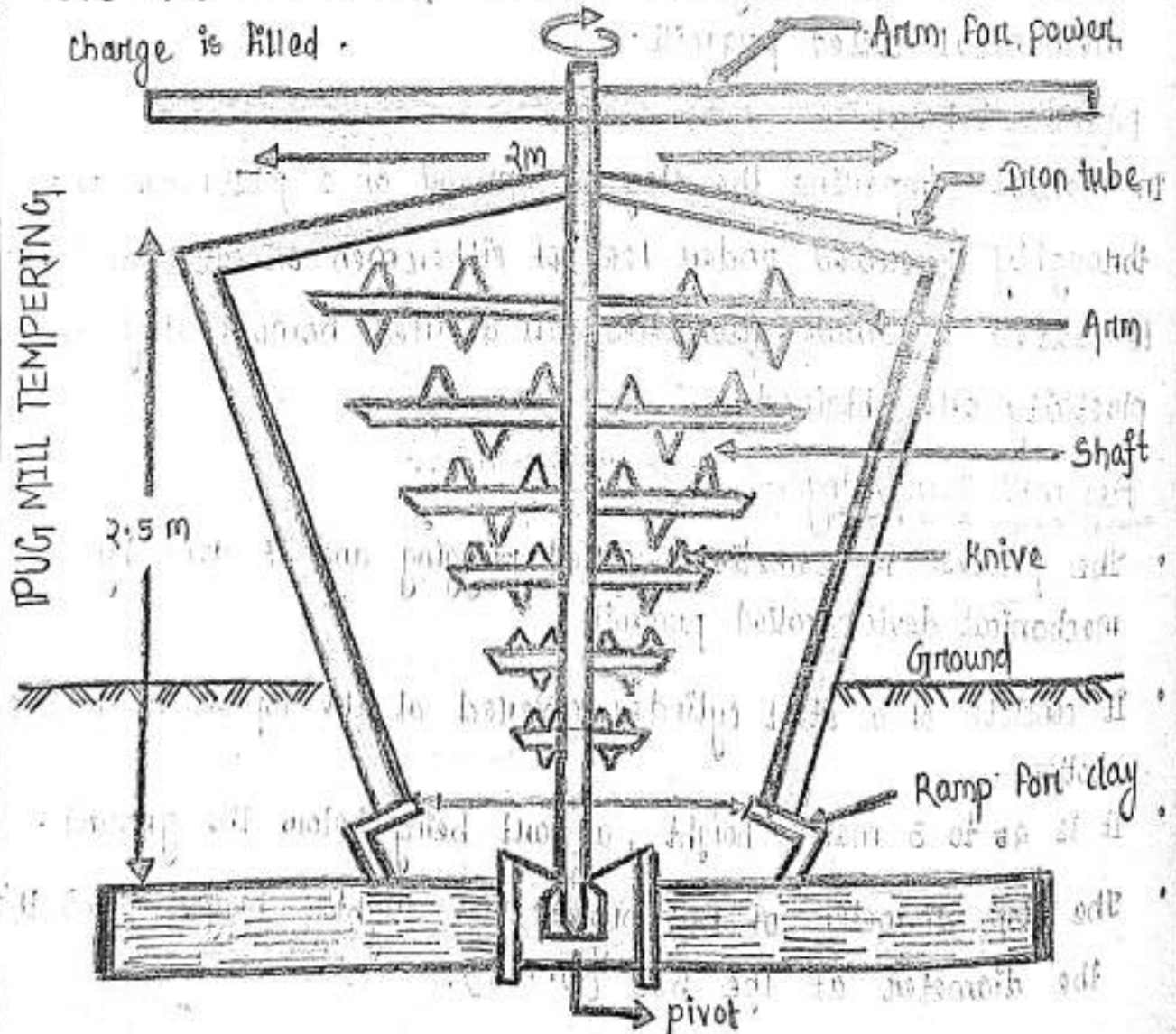

## Site Investigation

possible questions in exam.

1. Why inspection of site for construction of a project or what are the objectives of site investigation?

Answer

1. To know the foundation details.
2. To know the nature and thickness of strata of soil.
3. To decide the type of foundation.
4. To know the behaviour of ground due to variation in depth of water level.
5. To know the storm water at site and to think about how to disappear storm water from foundation.
6. To know the nature of soil by visual examination.
7. To know the movement of ground due to any reason.

## Examination of ground.

1. Why site reconnaissance is required in a project?

Answer

The load of the structure is transferred to the soil so it is essential to know the quality and thickness of soil underground for selecting an economical and safe design of foundation.

Note :- • pressure distribution under the foundation depends homogeneity of the soil and flexibility of base.

- pressure or load distribution from the superstructure should be decreasing towards the base to avoid failure of structure.
- pressure or load distribution from the superstructure is uniform so that it can resist induced moments and shear at base of foundation.

3. Why subsoil exploration is required?

Answer

The subsoil exploration gives precise information with respect to the following conditions at the site of the proposed project work.

- To know the location of groundwater and its variation.
- To know the nature and engineering characteristics of soil and rock formation.
- To know the order of occurrence and extent of different soil strata.

4. What is significant depth?

Answer

The depth upto which the increase in pressure due to structural loading is likely to cause perceptible settlement or shear failure of foundation.

- Note :-
1. loose soil - bearing capacity  $(80 \text{ kN/m}^2 \text{ or } 8 \text{ t/m}^2 \text{ to } 100 \text{ kN/m}^2 \text{ or } 10 \text{ t/m}^2)$ .
  2. sound hard rock - bearing capacity  $4500 \text{ kN/m}^2 \text{ or } 450 \text{ t/m}^2$ .
  3. yielding soil - settlement occur.

Stages - 3: Moulding of Bricks

Moulding is the process of making green bricks of proper shape and size from thoroughly tempered clay. There are two main methods of moulding.

1. Hand moulding.
2. Machine moulding.

Hand Moulding.

- In India the most common method for brick manufacture from the tempered mud is hand moulding.
- In hand moulding the quality of tempered clay is soft and can give desired shape easily.
- In this process mud contains more water (18-25%) by weight than machine moulding. So the process is called soft process of mud.
- The bricks can be made shape from the soft mud by hand on a specially prepared ground (called ground moulding) or on specially designed tables (called table moulding).

Tools The essential tools used in the hand moulding process are-

1. A brick mould.
2. Cutting wire or edge or strike.
3. Wooden plates or pallet.
4. Stock board.

1. The mould is made of wood or steel. Its inside dimensions are kept slightly bigger than the desired dimensions of the finished

brick. This is done because the bricks on drying are liable to shrink in size. The mould may be a single unit or a multiple unit type.

2. The stock board also called moulding block, is a small wooden board with a raised central projection carrying the identification marks (frog) of the manufacturer.
3. The stock board are the wooden plates used for handling the green bricks from the moulding boards to the drying fields.
4. The strike made of wood or metal, has its one edge quite thin to slash surplus mud from the top of the moulded brick while it is in the mould. Sometimes a thin wire string in a wooden block for holding is used for the same purpose, it is called cutting wire.

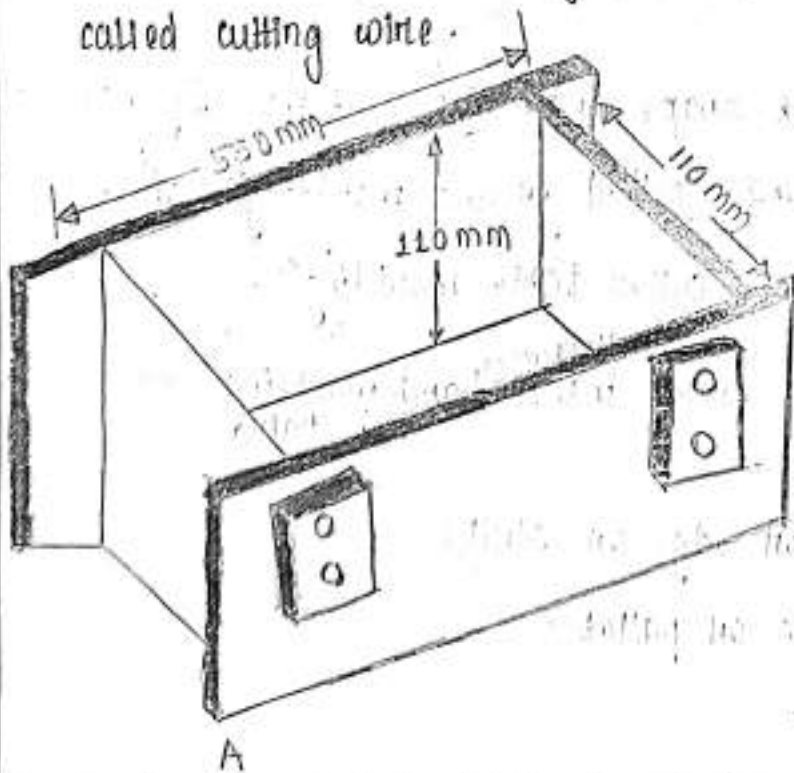



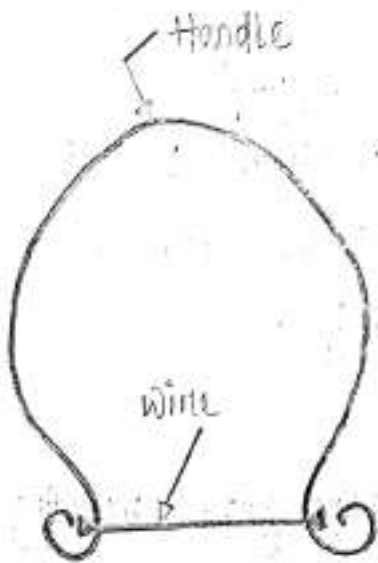
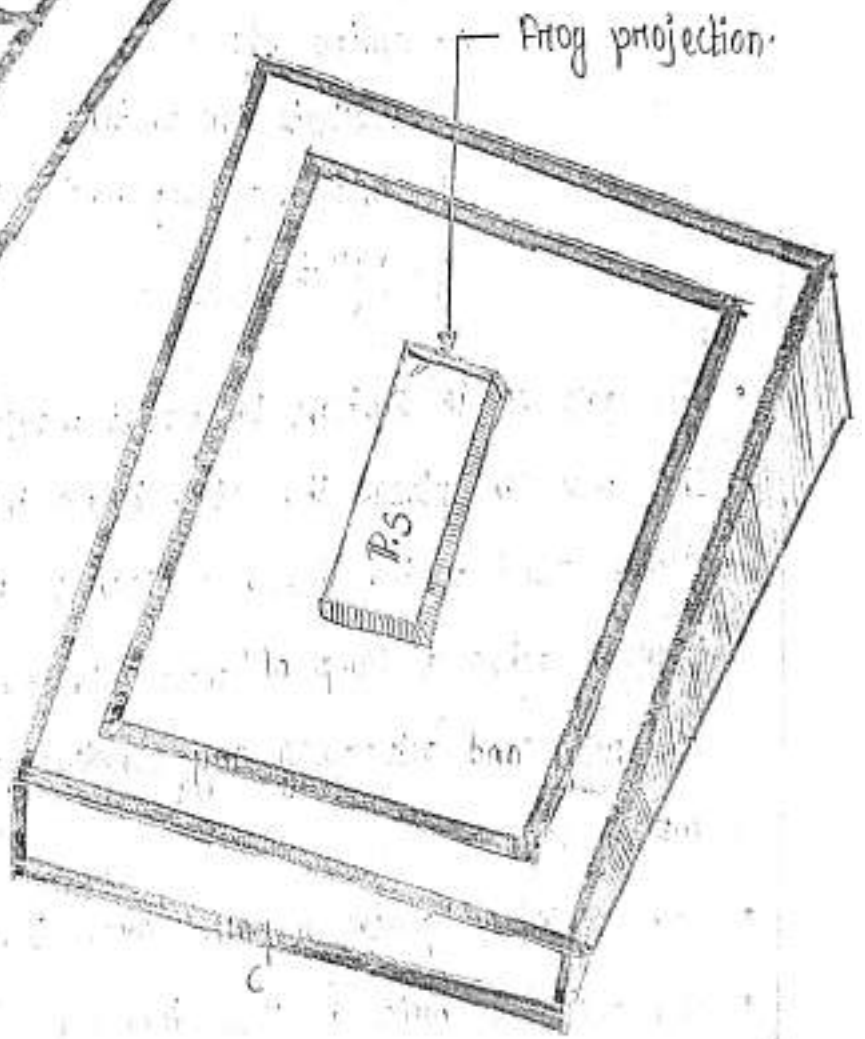
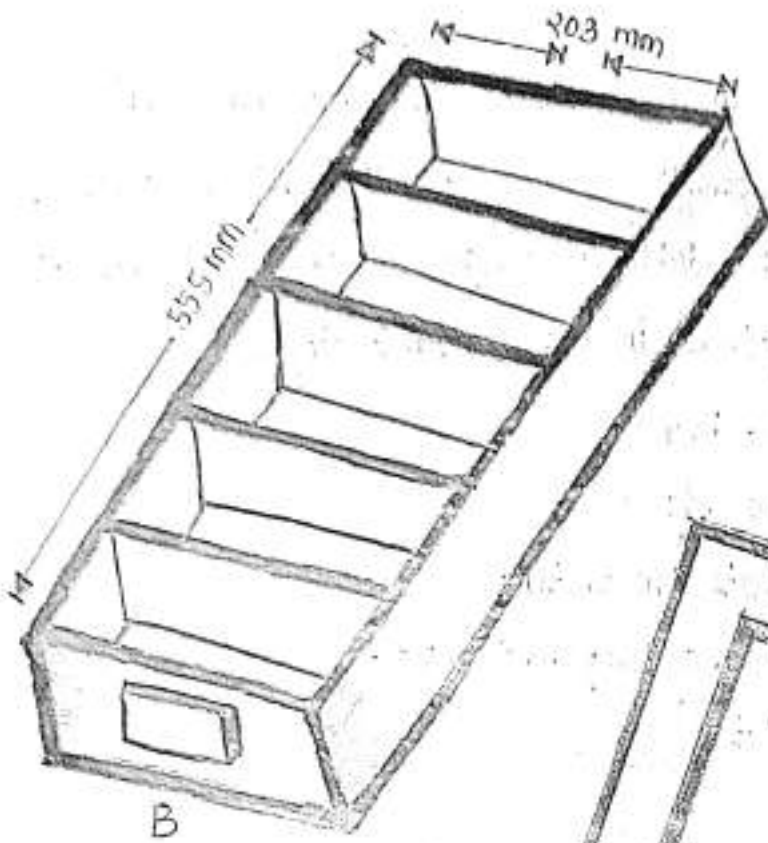

## Table Moulding

In this process, the skilled worker or the moulder carries out all the moulding operations on a specially designed table of suitable dimensions. Such a table is large enough to accommodate all the materials required in the hand moulding.

1. A stock board.
2. cutting edge.
3. Buckets for water.
4. sand and tempered mud.
5. pallet.

## Process

- The process is similar to pallet moulding on ground.
- The moulder places the stock board in front of him, sprinkles some sand on the inside surface of the mould, places it on the board, dashes a lump of mud into it, presses it thoroughly and skillfully and cuts away any surplus mud with the stroke on the cutting edge.
- Then moulder places a pallet over the mould and turns it over.
- The moulded brick is then transferred to the pallet, and which is carried away by a helper standing near by.
- Repeat the process for each brick.
- In this process initial cost is high comparing ground moulding but it is efficient and economical in the long run as production is better in quality and quantity.

### Useful purpose of frog

1. The name of the manufacturer of the brick is easily found and he can be known for the quality of the brick.
2. During use, the frog-faced side is placed upward. It accommodates some extra mortar and the key action forming a bond of greater strength between the upper and lower brick in the construction work.

### Ground moulding

This is the most common method of moulding bricks in our country. In this process a stretch of land is first flattened, levelled and cleaned. It may be smoothed by mud plastering. Some sand is sprinkled uniformly over it to make it non-sticky.

There are two variations of ground moulding.

a) For making ordinary bricks:-

- The mould is either first dipped in water or some sand is sprinkled on its inside surface.
- The first method is called slip moulding and the second method is called sand moulding.
- The step is necessary to avoid sticking of the green mud to the inner sides of the mould.
- Then the mould is placed on the ground at desired spot.
- A lump of mud is dashed into the mould by hand.
- Care is taken to see that the mud reaches to the sides and corners of the mould.

- Any surplus mud is then removed by using strike or cutting wire.
- The mould is then lifted up with a jerk leaving behind the moulded bricks on the ground below.
- Repeat the same process and the face of the brick that rests on the surface is naturally rough and without any identification mark.

### Moulding bricks with frog -

- This is achieved by using a stock board and pallets.
- The stock board is provided with a raised projection - carrying trade mark (identification mark) of the brick manufacturer.
- Here the mould is placed on the stock board instead of ground.
- The brick is taken away using two pallets to the drying side.
- This process is called pallet moulding.

### Machine Moulding

- Machine moulding is the essential process in all mechanized brick making plants.
- It is both cheaper in the longer run and gives bricks of uniform quality.

There are two methods.

a) stiff mud process

b) dry press process

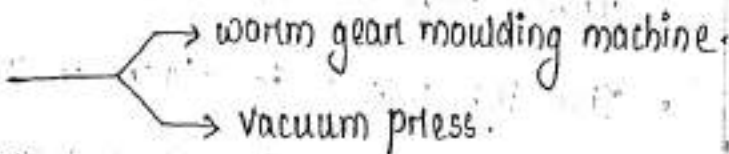

a) stiff mud process

In this method thoroughly cleaned brick clay is mixed with small quantity of water (8-12% by volume) during

during tempering in pug mills so that it is quite stiff in consistency and stiff mix is then passed out under pressure from a moulding machine.

### Worm gear moulding machine.

- i) A feeding chamber provided with a worm gear to apply pressure.
- ii) A hopper at the top to receive the clay mix from the pug mill.
- iii) A fixed die provides at the front narrow end.
- iv) A conveyer belt on a set of rollers.
- v) cutting wire device adjusted in front of the die.

### operation steps.

- a) Feeding the properly mixed stiff mud in to the chamber through the hopper.
- b) forcing forward the mud charge using the worm gear.

### Process

- The pressed mud comes out through the die in the form of a continuous rectangular ribbon having the height and width of the bricks.
- The ribbon gets cut into brick length by pressing down the cutting wire device when the conveyer belt is under the device.
- The cutout bricks are then carried forward on the conveyer belt and taken away for drying.
- The length can be cut edge-wise or sides depending on the die.
- The machine can mould 1000-2000 units per hour or as per designed capacity of machine.

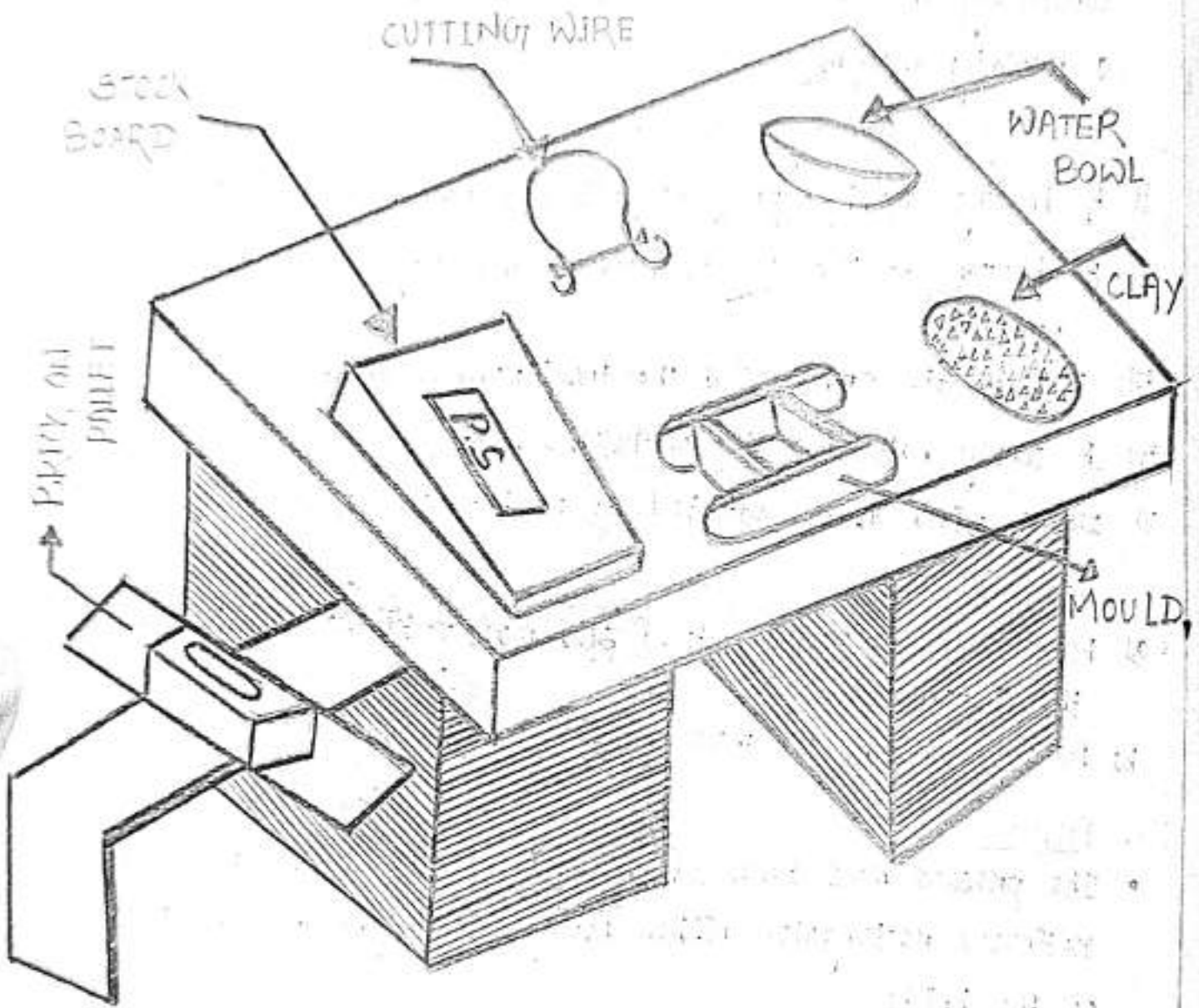

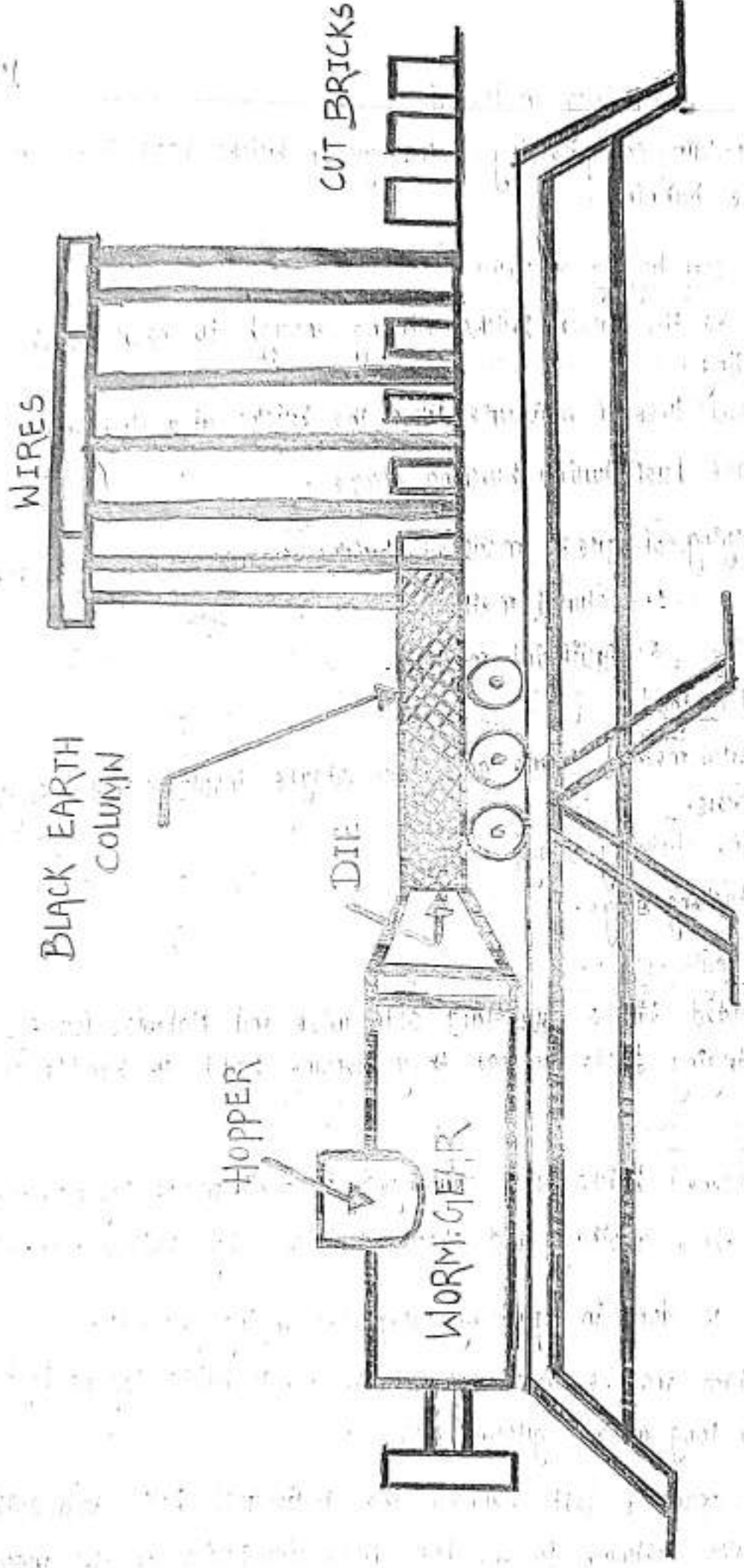

After moulding (or pressing), the green bricks have to be dried before burning.

Reason for drying of bricks.

1. To make the green bricks strong enough to bear rough handling.
2. To allow loss of moisture from the bricks at a slow rate.
3. To save fuel during burning stage.

Drying of green moulded bricks is achieved by two methods.

1. Natural method.
2. Artificial method.

Natural method.

In natural method there are two stages involved in the drying process.

1. pre stacking stage.
2. stacking stage.

prestacking stage.

The moulded bricks are laid side wise and flatwise for 2-3 days in the drying fields so that they become hard to handle stacking.

Stacking stage.

1. The hardened bricks are arranged in well made layers, one layer above another and should be done by skilled workers.
2. stacking is done in specially prepared drying grounds.
3. Each stack may be about 100 cm wide, 10 bricks layers high and as long as the ground allows.
4. enough space is left between the individual brick in a stack and also between layers for free circulation of air around each brick.



5. The stacks are properly protected from direct sun, rain and strong wind.

### Air drying method.

This process may take 4-10 days depending upon the season and place of drying and after dried the brick still remain 2-4% moisture in the air.

### Sun dried bricks: Adobe.

1. The sun dried bricks are also called Adobe.
2. These bricks can sustain enough load in small construction also resist continuous rain.

### Artificial drying.

- This method is essential in mechanised brick making units.
- Bricks can be dried throughout the year independent of weather condition.

Artificial drying can be done by:

1. Chamber drying.
2. Tunnel drying.

### Chamber drying.

- In chamber drying, bricks are arranged in stacks within specially designed drying chambers and keeping sufficient spaces for free circulation of hot air around them.
- Hot air under controlled condition of temperature and humidity is made to circulate through these stacks for 2-4 days or more.
- The dried bricks are then taken out and next batch of green bricks is stacked in layers within the chamber.

### Tunnel drying

- In tunnel drying, bricks are stacked on mobile carts that are made to travel on rails within a specially designed drying tunnel.
- The tunnel is divided by into compartments and each cart loaded with green bricks is made to stay in a particular compartment for pre-fixed duration.
- The carts come out from the other end of the tunnel one by one and this process may take 2-3 days for a cart load of bricks to dry to desired extent.

### Stage V Burning of Bricks

#### Need

- After burning dried bricks develop desired building properties such as, strength, hardness, durability and resistance to decay and disintegration.
- At least three chemical changes takes place in the bricks earth during burning process.
  1. dehydration.
  2. oxidation.
  3. vitrification.

Dehydration - It means complete removed of water from the pores of the bricks.

Oxidation - All the organic matter in the brick earth gets oxidised and carbon, sulphur are eliminated also during flux

the lime, magnesia and iron becomes reactive at these temperatures. The brick acquires the red colour due to iron in the clays.

Vertification - In this process the constituents of clay, i.e., alumina and silica start softening. The constituent grains get bound firmly.

### Methods of Burning:

Bricks are burnt in two ways.

1. clamp burning.
2. kiln burning.

1. clamp burning is called as *parwas*.
2. the working arrangement for burning bricks without making any permanent structure.
3. In this process alternate layers of dried bricks and any locally available fuel of ordinary type are stacked together upto a desired height on a properly prepared ground.
4. The heap made is then plastered from outside with mud.
5. It is ignited from the base and allowed to burn for a month also allowed to cool for another month.
6. In a clamp of  $10\text{ m} \times 7.5\text{ m}$  sides, about one lakh bricks burnt in the month.

### Advantages.

1. It is easy to erect and operate.
2. Any type of fuel can be used in clamp burning.
3. It requires least supervision after burning.
4. It is economical.
5. It gives ordinary bricks of less strength.

### Disadvantages

1. Burning of bricks is not uniform and some bricks at the lower end get over burnt while as bricks from middle and upper regions of the clamp remains under burnt.
2. Burning cannot be burnt.
3. Bricks get damaged due to crumbling and falling when the intervening layers of fuel get burnt.
4. Time required for burning is too long.

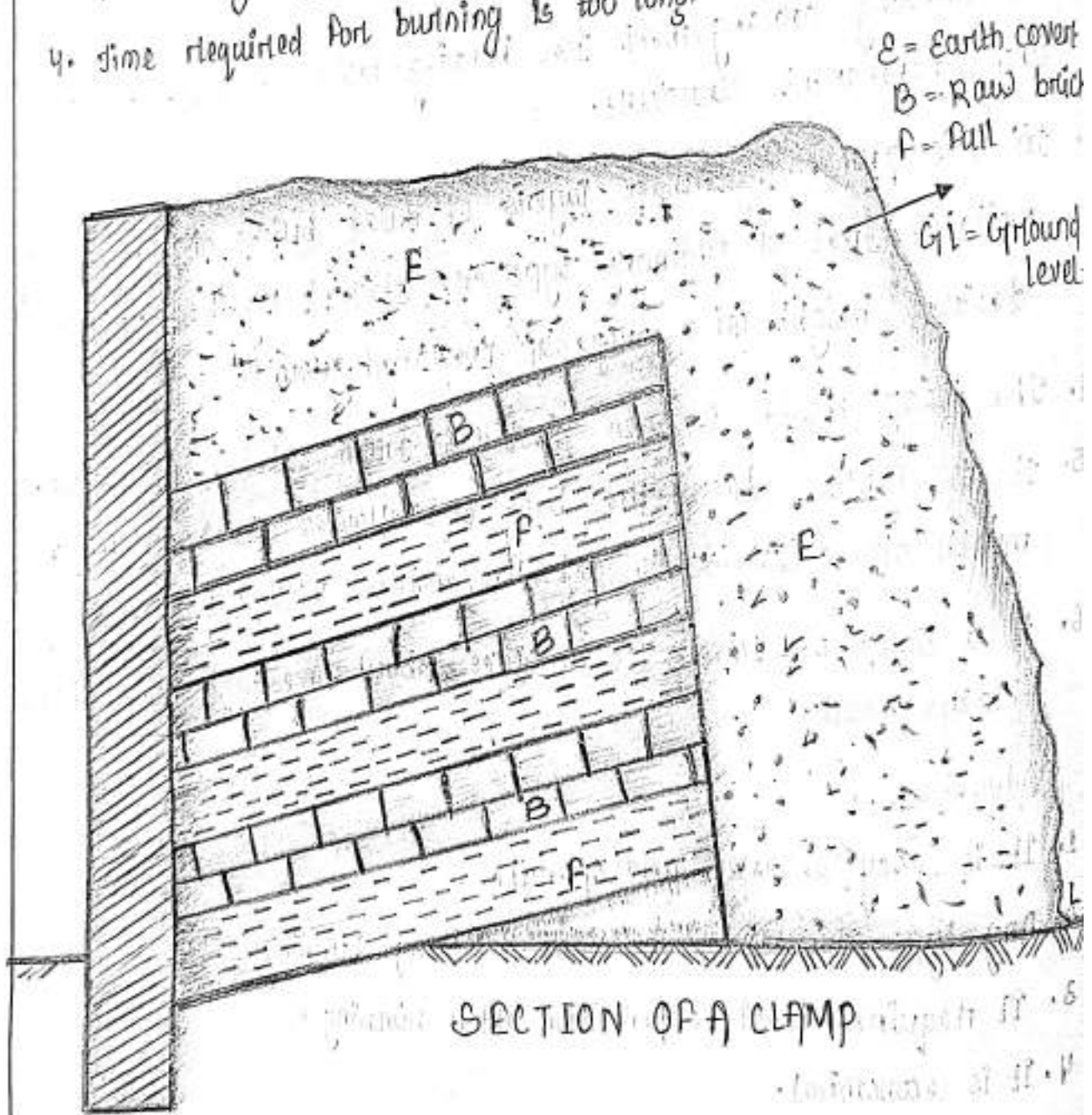

## B. Brick making

The permanent structures which are used for burning of bricks is called kilns. It is divided into the two groups basing on their principle of construction.

1. Intermittent kilns.

2. continuous kilns.

### 1. Intermittent kilns

i. In intermittent kilns burnt bricks can be made available only after a definite interval of time after put on fire.

ii Here the brick supply is intermittent.

### 2. continuous kilns

i. Here the brick supply is continuous.

ii It consist of a number of chambers.

iii It is a controlled process, when one chamber is in the loading - the another chamber in the burning stage, a third chamber in the preheating stage, a fourth chamber in the cooling stage and a fifth chamber in the unloading or supply stage.

iv the operation are shifted from chamber to chamber in such a manner at any time one chamber is available for unloading.

## BULL'S TRENCH KILNS

Principle: 1. It is a continuous type of kiln is used for burning of brick.

2. It has number of compartments or sections and can be operated indepently as well as in a required process.

Construction: 1. The kiln may be of semicircular or rectangular outline in plan.

2. It is excavated below the ground level to conserve maximum heat during the burning process.
3. The dimensions of the trench depends upon capacity of bricks.

Length - 50 to 78 m width - 6-8 m . Depth - 1 to 2 m .

4. A typical trench kiln has two walls both made of bricks.

5. The inner wall is continuous and outer wall has number of openings or gates.

6. The gates are provided with dampers or doors and can be operated opened or closed by railway or lowering the dampers as desired by the operator.

7. It has 6 to 12 interconnected compartments inside the kiln.

8. Kiln is provided with chimneys placed at the top for exhaust gases and can be shifted from one compartment to another.

Loading: 1. In this process stacking of bricks is done carefully within the kiln such that enough space is left between any two bricks in a layer for free circulation of hot gases around them.

2. The top of the loaded section is thoroughly covered with 40 to 80 cm deep layer of ash and dust taking care that none of the openings from the kilns get blocked in the process.

Burning: Here required volume of air is supplied by regulating the opening and raising of the gates or the dampers provided in the outer walls. Additional quantities of fuel may be added from the flues at the top. It takes 24 to 30 hours for perfect burning.

Cooling: In this stage all the outer gates are closed by lowering the dampers and interdepartmental gates are opened up for leading the hot gases to the preheating sections. It takes 3 to 4 days to cool down completely before unloading can be started from it.

Unloading: The top layer of dust and ash are removed and put to unloading. The bricks are removed from the top to bottom one by one and taking care that they are not broken during unloading and handling process.

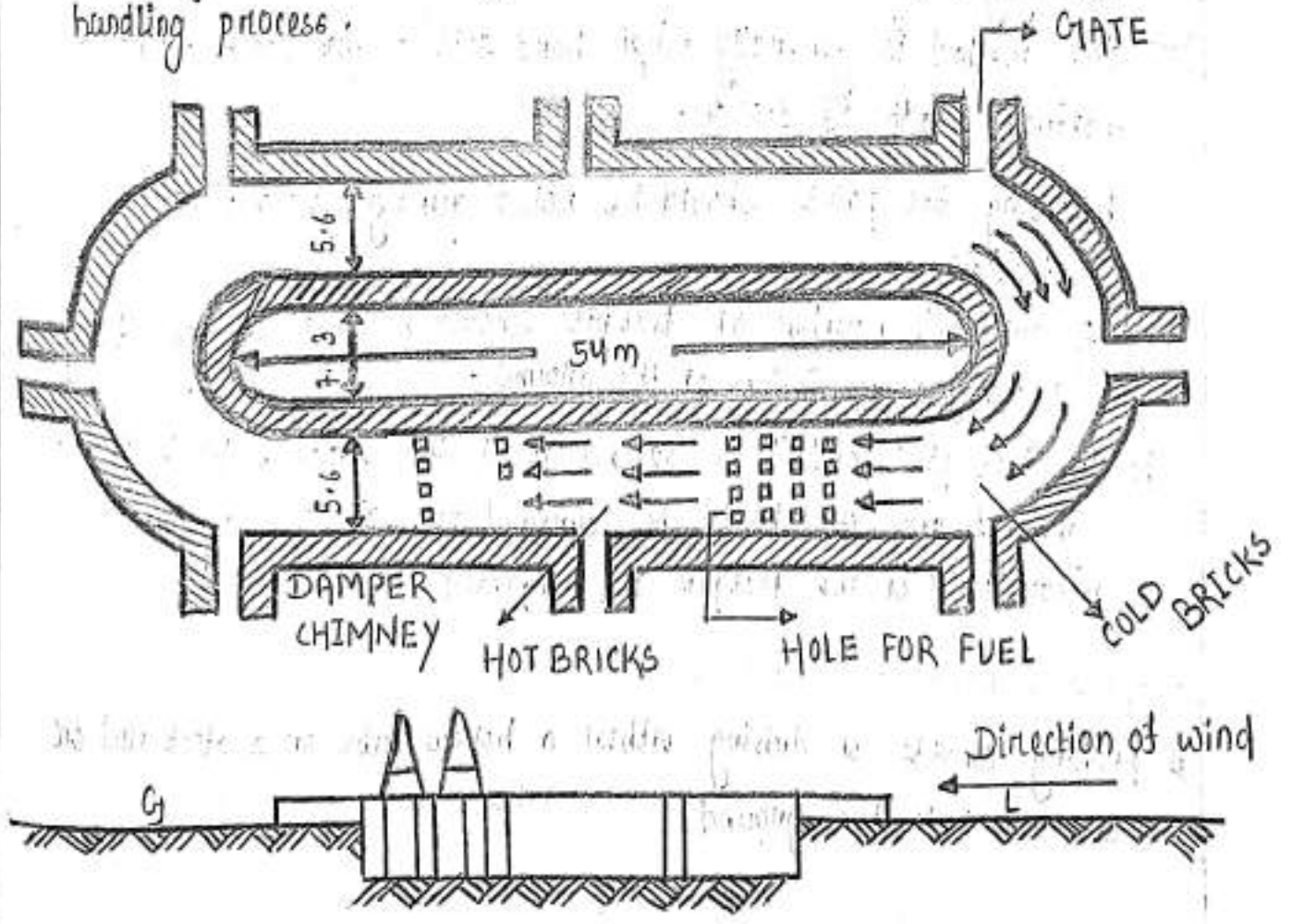

## Site Exploration

Following are the various methods of site exploration.

1. Test pits.
2. Probing.
3. Auger boring.
4. Wash boring.
5. Test piles.
6. Deep boring.
7. Geophysical method.

### 1. Test pits

- i) A square pit, known as a trial pit or a test pit with side as about 1.50 m, is excavated up to a depth at which sufficiently hard soil is available.
- ii) Various strata of the soil can be inspected, studied and classified accordingly.
- iii) This method is generally when hard soil is available within a maximum depth of 1.50 m.

- Following two points should be noted during excavations of test pits.

- a) A sufficient number of test pits should be dug on the site to know the variation of the ground.
- b) The test pits should be extended at all the exposed levels of the ground and it should be carried out as soon as the excavation of the test pits is completed.

### 2. Probing 1st case - 1st case

- i) Probing consists of driving either a hollow tube or a steel rod or an iron into the ground.



- iv A hollow tube of diameter 35 mm to 60 mm is taken.
- iv It has a slit of a 3mm thickness. In the bottom portion of 60 cm and the tube is driven into the ground, at a time also withdrawn and the material caught in the slit is inspected.

### 2nd case

- i A solid rod of steel or iron having a diameter of about 20 mm to 35 mm is taken and driven into the ground.
- iv The rod has a pointed end and frequently with drawn also see the material stuck up at the pointed end and examine the soil.

### 3. Auger Boring

An auger may be three types.

1. post hole type.
2. screw type.
3. shell type.

#### Typical shell type Auger.

1. It consist of a hollow tube of diameter 75 mm to 100 mm. The tube is provided with a cutting edge at the bottom.
2. A slit extending over a length of 60 cm to 90 cm is provided at the bottom of the tube to catch the material.
3. The length of the tube is 1.50 m and it is provided within a threaded end so that it can be suitably extended within the help of lengthening pieces.
4. The auger is worked like a leverage at the top.
5. The auger is driven and turned like a screw then the auger is withdrawn and the material caught in the slit is inspected.

6. When the auger is to be drawn in loose sand to prevent collapse of the loose material when within drawn a casing may be given which is bigger diameter a head of the auger to prevent collapse of the loose material.
7. Lengthening of the casing can be done by connecting one pipe to the other.
8. It is possible to inspect the ground for a depth of 6m to 8m also this shell type can be used for loose soil upto a depth of 15 m.

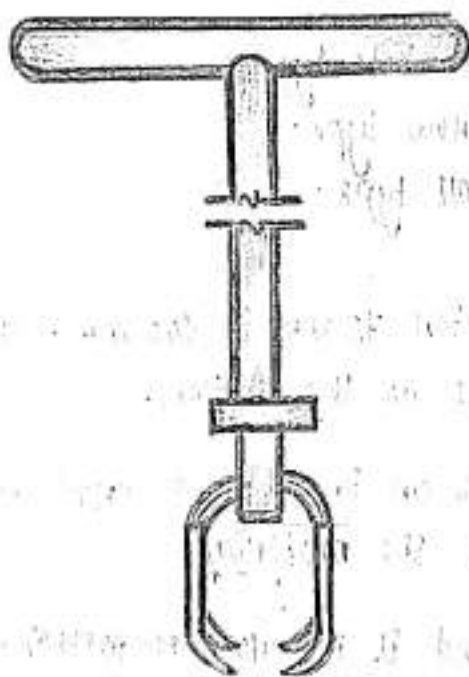

Fig. 1-4

POST-HOLE AUGER

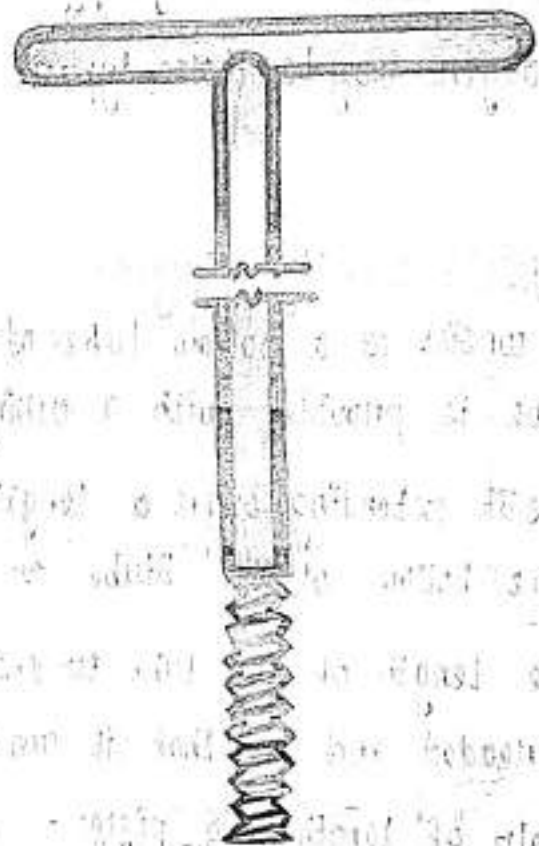

Fig. 1-5

SCREW AUGER

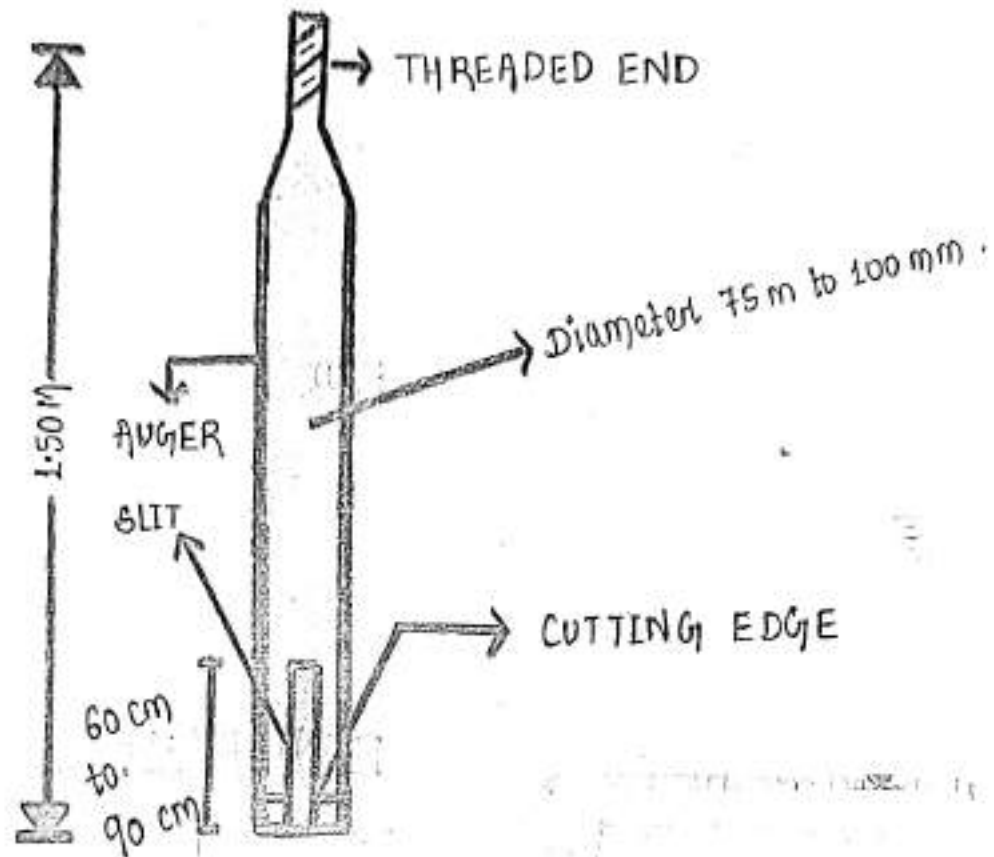
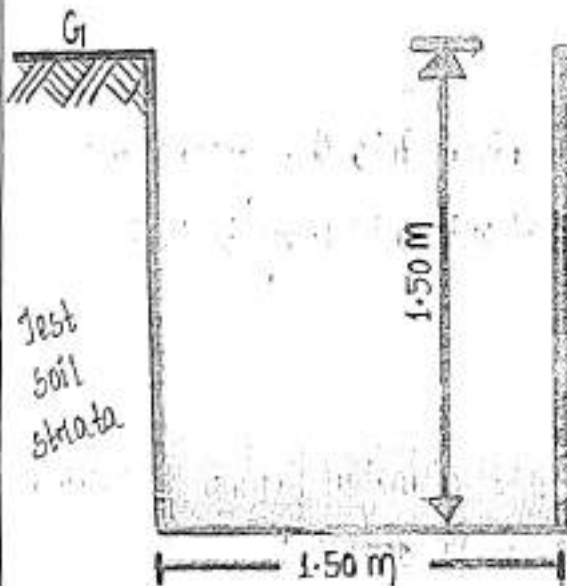

FIG. 1-6  
SHELL AUGER



TEST PIT  
FIG. 1-1

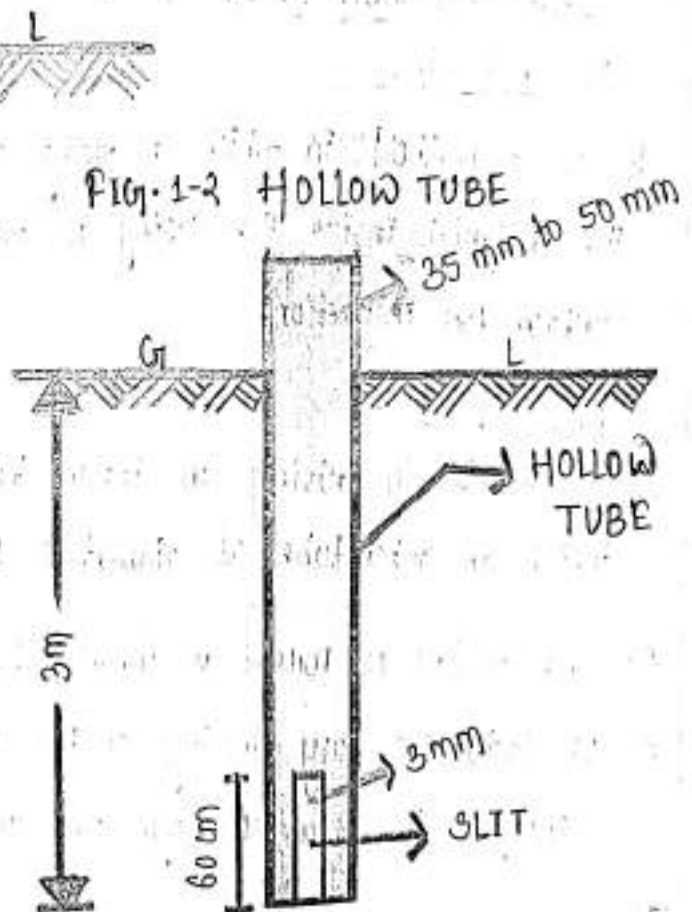
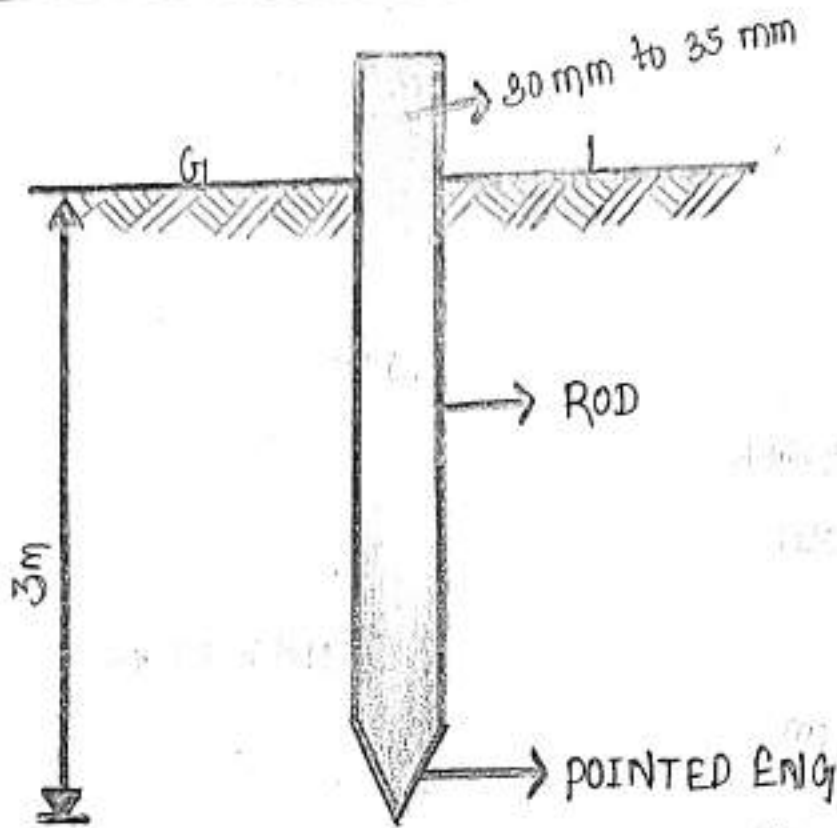

FIG. 1-2 HOLLOW TUBE



ROD  
FIG. 1-3

## Construction Technology Wash Boring

It is a method in which a casing is driven into the ground and the material inside the casing is washed out and brought to the surface for inspection.

### Process.

1. It consists in driving an inner tube of diameter 25 mm to 50 mm, inside an outer tube of diameter 100 mm to 150 mm.
2. The water is forced in inner tube under pressure.
3. It facilitates easy driving of the tube and makes the soil loose enough to flow through the annular space.

4. The quantity of water required is about 100 to 200 litres per unit minute under a pressure of  $26.48 \text{ kN/m}^2$ .

5. The process is continued till hard surface is met with and then washed material is collected in a tank and studied carefully.

### Note

i) In case a boulder is met small charge of dynamite should be used to dislocate the boulder and then the work should be started again.

ii) In the process of washing, the finer particles such as loam, clay may disappear and they are separated from the coarse particles.

iii) The results obtained in this process upto a depth of 30 to 45 m.

### Sub-surface soundings

In this method, the resistance of the soil with depth is measured by means of a tool known as penetrometer under static or dynamic loading and the penetrometer may consist of a sampling spoon, a cone or tool of other shape.

### Procedure

i) The penetrometer is driven in the ground with the help of blows from a 650 N weight falling from a height of 750 mm.

ii) The number of blows required to drive the penetrometer into the ground through a distance of 300 mm is measured. It is known as the standard penetrometer resistance or SPT of the soil.

iii) The values of SPT of soil at different depths are determined.

iv) The bearing capacity and other engineering properties of certain types of soil are then known as referring to the curves

correlating opt and the corresponding characteristics of soil. These curves are available for ready reference.

USE :

- a) finding the depth of bedrock or stratum
- b) knowing the general exploration of erratic soil profiles.
- c) Testing cohesionless soils from which it is difficult to obtain the undisturbed samples.

Test piles

- 1. Test piles are driven into the ground, to know the information of the solid strata of soil.
- 2. It is not possible to know the kinds of all strata of soil which the test piles pass and material is not available for inspection.
- 3. The factors such as the resistance of soil load bearing data and total information may be available from this test also useful guides for construction.
- 4. In fact, experience has shown that in piles of all kinds flaws may occur.
- 5. The purpose of integrity testing is to discover such flaws before they can cause any damage.

Example -> Nuclear radiation or (gamma-gamma) method  
 short wave (ultrasonic)  
 long wave (sonic)

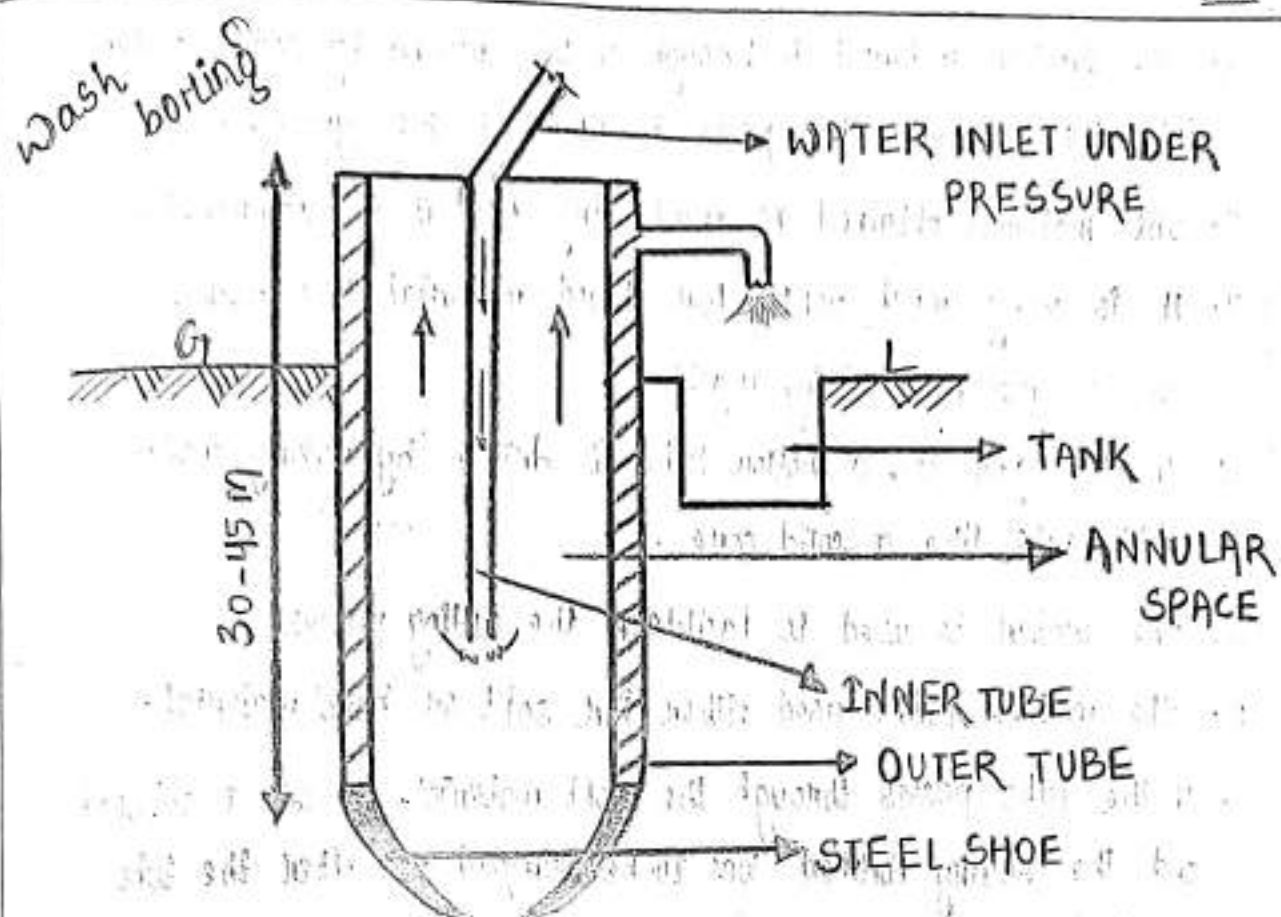

## Construction Technology

### Deep Boring

1. It is essential to carry out deep boring for big important engineering structure such as dams.
2. In such structures in addition to the stability of the superstructure, the importance is to be given to various other factors such as non-leakage of the stored water, seepage through porous strata.

The machines used for deep boring:

i) percussion boring machine:

ii) core or rotary drilling machine.

### Percussion boring machine.

1. In this process, the heavy cutting tool is dropped into the ground by means of a series of blows.

2. The broken material is brought to the ground by adding water into the core and then paste is lifted to the ground.
3. The material obtained is made dry and it is examined.
4. It is very much useful for hard material like rock - core on rotary drilling machine.
1. In this process, a hollow tube is driven by rotary motion which cuts like a solid core.
2. The water is used to facilitate the cutting process.
3. The machine can be used either for soft or hard material.
4. If the tube passes through the soft material, no core is obtained and the slurry formed has to be pumped out after the tube is withdrawn.
5. When the tube passes through the hard material, the core is retained and this has to be cut at the bottom and lifted up.
6. This is done by pouring sand at the inner surface of the tube and the core also the tube is slightly rotated.
7. The core is then broken and caught in the tube along with sand and it is lifted up.
8. Then core chart is prepared and to prevent the falling of loose material, when the tube is removed casing may be used.



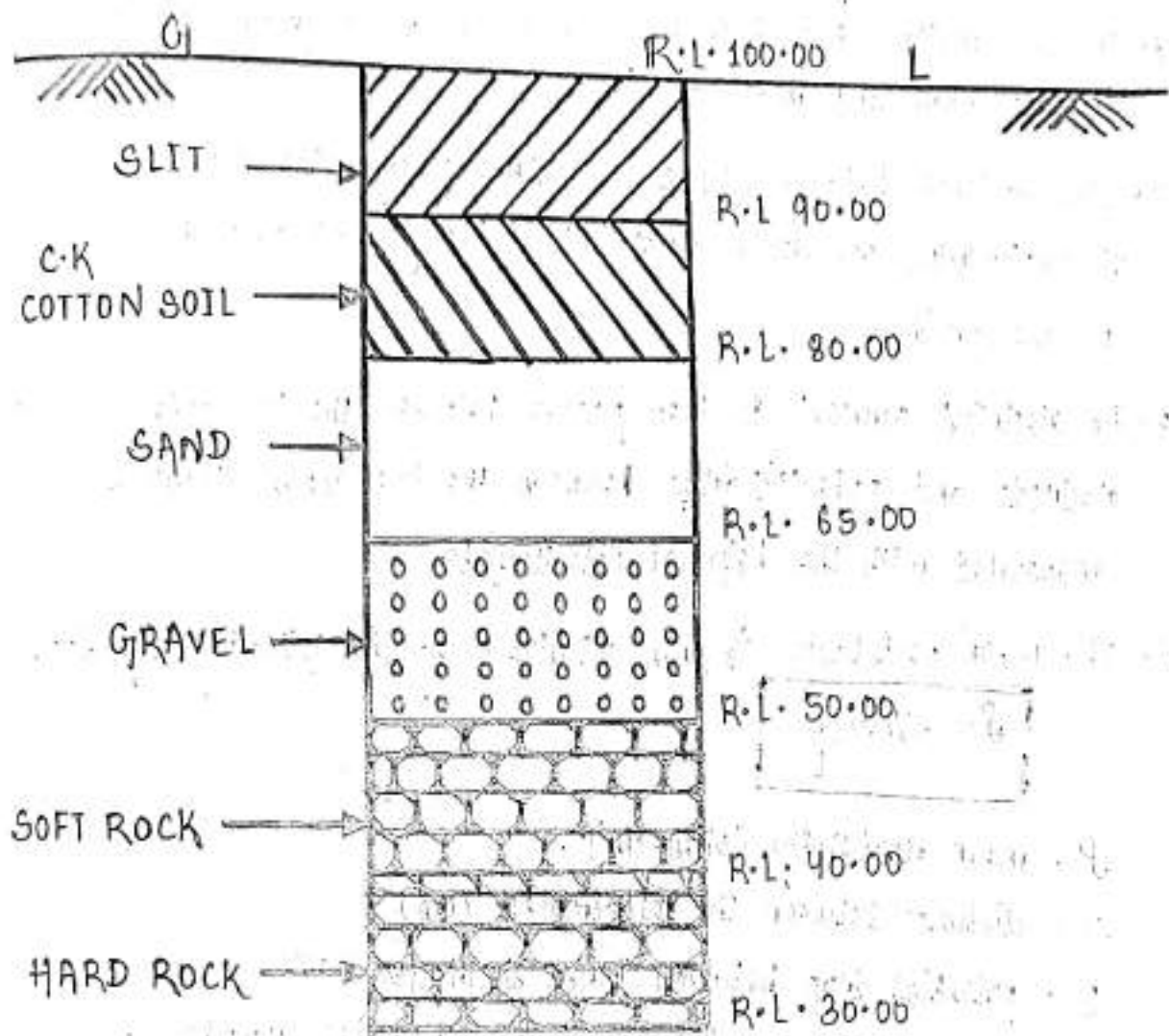

CROSS-SECTION OF A TYPICAL BORE-HOLE

### Geophysical method

1. In geophysical method we will be able to know the nature of soil strata.
2. These methods are used when the exploration depth is substantial and the speed of investigation is of primary importance.
3. These methods are mainly adopted to know the depths at which useful minerals and oils are available.

In civil engineering purposes two methods are adopted:

1. Electrical resistivity method.
2. seismic refraction method.

### Electrical resistivity method.

1. In this method four electrodes are driven in the ground at equal distance apart and in a straight line.
2. The distance between the two electrodes indicates the depth of exploration or depth up to which the ground resistance is to be measured.
3. An electrical current is then passed between the two outer electrodes and potential drop between the two inner electrodes is measured with the help of potentiometer.
4. The mean resistivity is then calculated by the following equation.

$$\rho = \frac{2\pi D \epsilon}{I}$$

$\rho$  = mean resistivity (ohm-cm).

$D$  = distance between the electrodes (cm).

$\epsilon$  = potential drop between inner electrodes (volt).

$I$  = current flowing between outer electrodes (ampere).

5. This method is based on the principle that each soil has different electrical resistivity depending upon its water content, compaction and composition.

Example The saturated soil have lower electrical resistivity as compared to the loose dry gravel or soil rocks.

6. The average values of resistivity for various types of soil have been identified by these tests.
7. It gives information the nature and distribution of soil formation by knowing the values of change in mean resistivity of subsil strata at site.

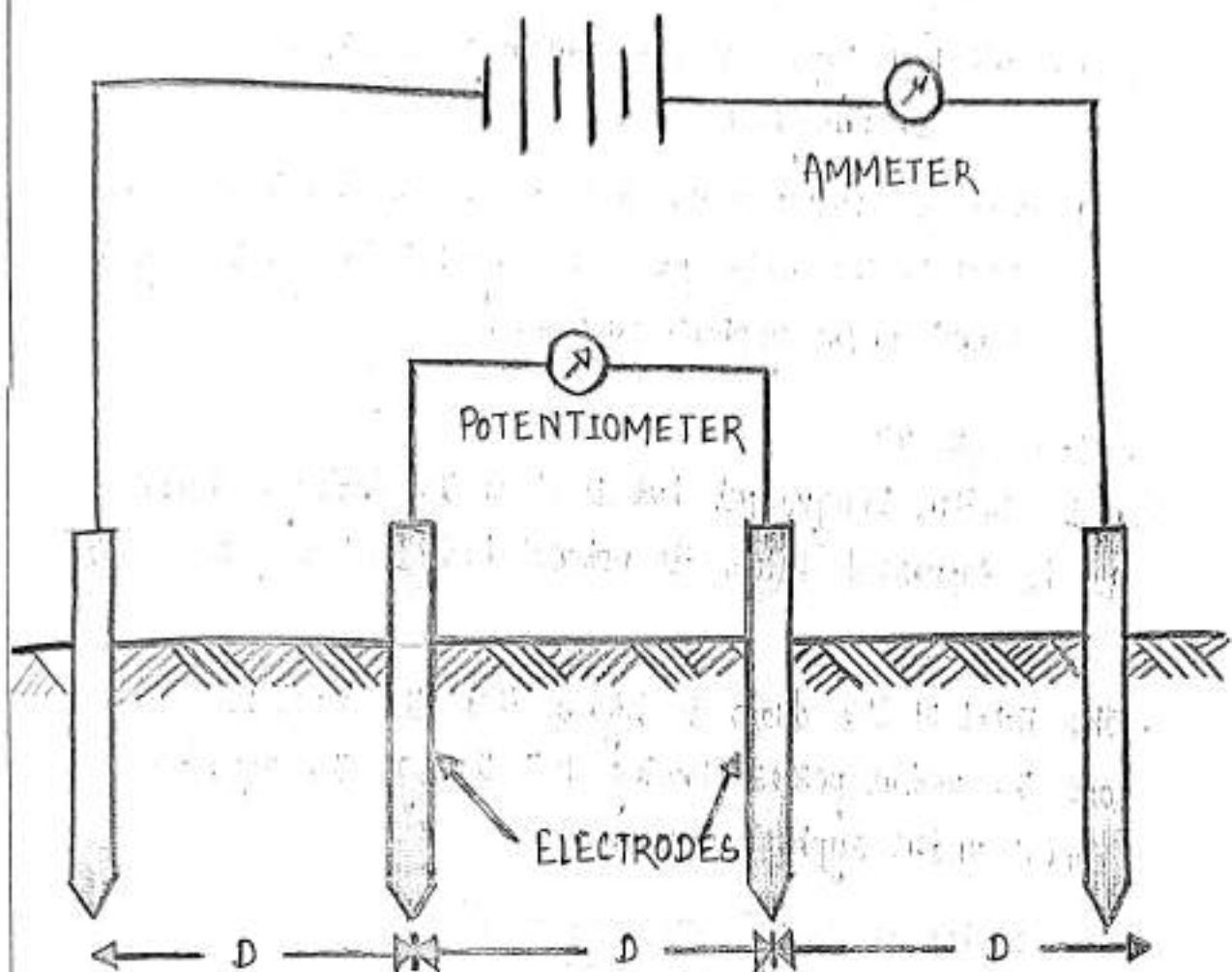

### ELECTRICAL RESISTIVITY METHOD

Fig. 4.9

### Cross drainage works

There are four types of cross drainage works.

1. An aqueduct
2. syphon aqueduct.
3. syphon or canal syphon.
4. sump passage or trough.
5. viaduct.

### Aqueduct

1. An aqueduct is a structure carrying an irrigation canal over a drainage channel without having a lower down.

Cross-drainage works.

There are four types of cross drainage works.

1. Aqueduct

point 1. The H.F.L of the drain is higher than the canal bed level to the water passes flowing full through the aqueduct barrel under syphonic pressure.

Syphon aqueduct

1. It is similar to aqueduct but level of the drainage channel has to be depressed below its natural bed level to pass it under the canal.

2. The H.F.L of the drain is higher than the canal bed level and the water passes flowing full through the aqueduct barrel under syphonic pressure.

canal syphon or simply called syphon.

1. When a canal is passed below a drainage channel or another irrigation channel by lowering down the bed of the canal the work is termed canal syphon or syphon.

2. The F.S.L of the canal is sufficiently above the bed level under syphonic pressure.

super passage or trough.

1. It is similarly to canal syphon but the bed of the canal structure for the crossing is not lowered down from its original bed level and water flows freely under gravity without any syphonic pressure.

2. The F.S.L of the canal remains sufficiently <sup>below</sup> ~~above~~ the bed level of the drain.

### Viaducts.

where one canal crosses another canal by means of a super passage is called super passage or viaduct.

NOTE: Headway: The difference in height between the drainage & maximum flood level and the canal bed level is called headway.

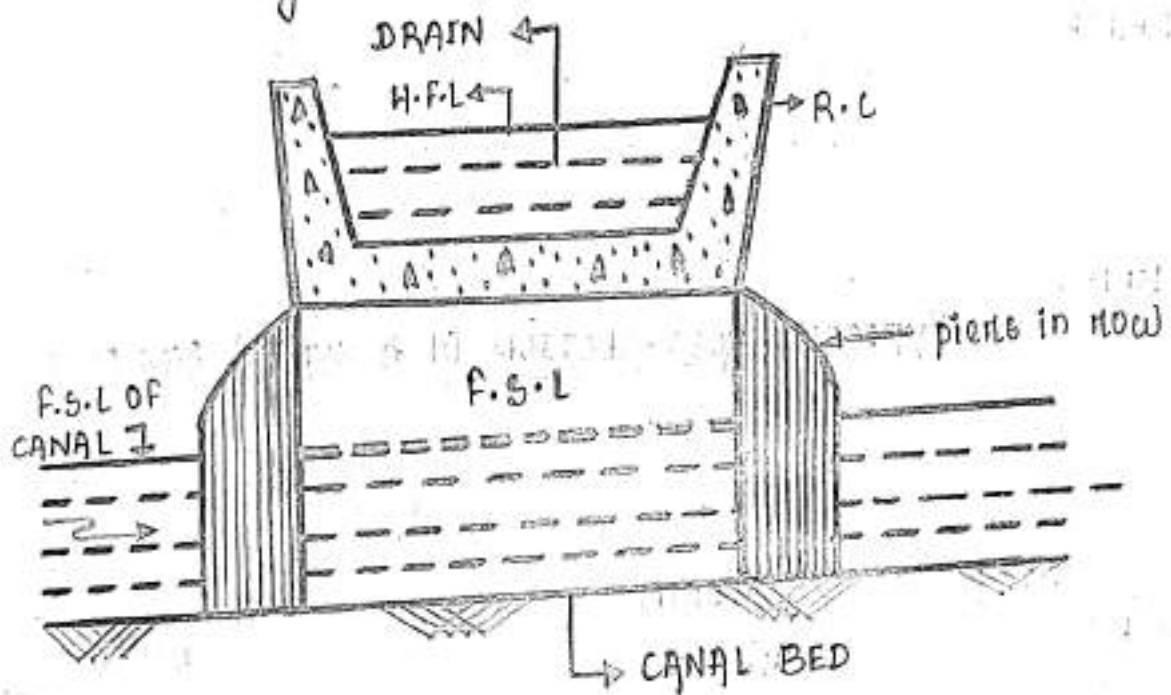

1. Typical cross-section of a super passage.

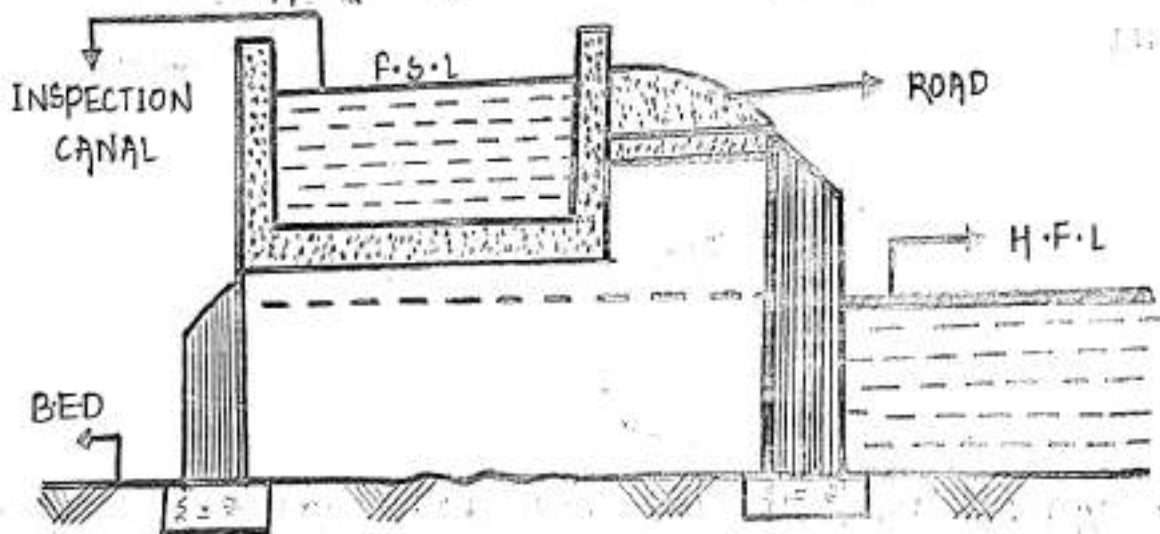

2. Typical cross-section of aqueduct

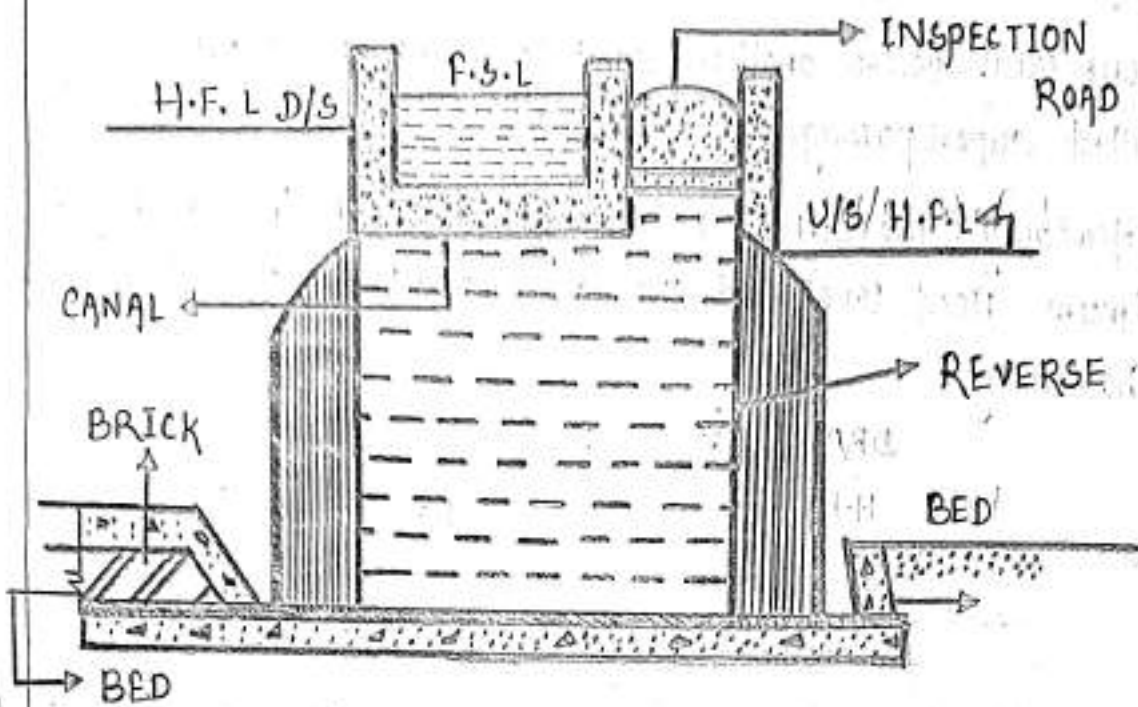

3. TYPICAL CROSS-SECTION OF A SYPHON AQUEDUCT.

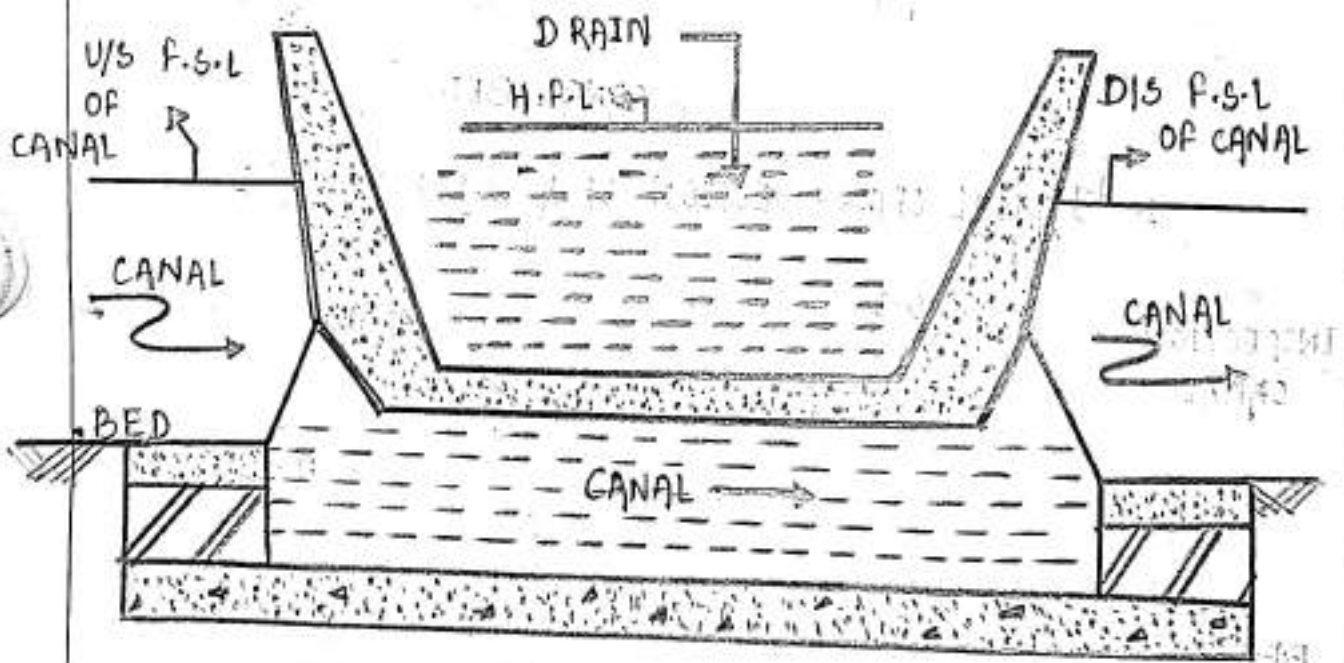

4. TYPICAL CROSS-SECTION OF A CANAL SYPHON OR SYPHON

## Methods of Exploration.

### Seismic refraction method.

1. This method is based on the principle that the vibration caused in the ground by artificial explosions travel faster in rock than in the soil.
2. The velocity of sound waves is different in different medium below the ground.
3. The artificial shock waves are developed into the soil at ground level or at a certain depth below it, either by exploding small charge in the soil or by striking a plate on the soil with a hammer.
4. The shock waves so produced travel down in the sub soil strata and get refracted after striking a hard rock surface below.
5. The refracted waves are picked up and their times of travel are recorded in the instruments known as the geophones.
6. A number of geophones are arranged along a line.
7. Some of the waves are picked up and their times known as direct or primary waves picked up at first by the geophones. The other waves travel down through the soil get refracted after striking a hard rock surface below.
8. The depth of various strata can be evaluated by knowing the times of travel of the primary and refraction waves and then preparing distance time graphs.

9. These graphs are helpful in establishing the identity of subsoil strata

10. The materials like clay, soft rock, hard rock have specific seismic velocities.

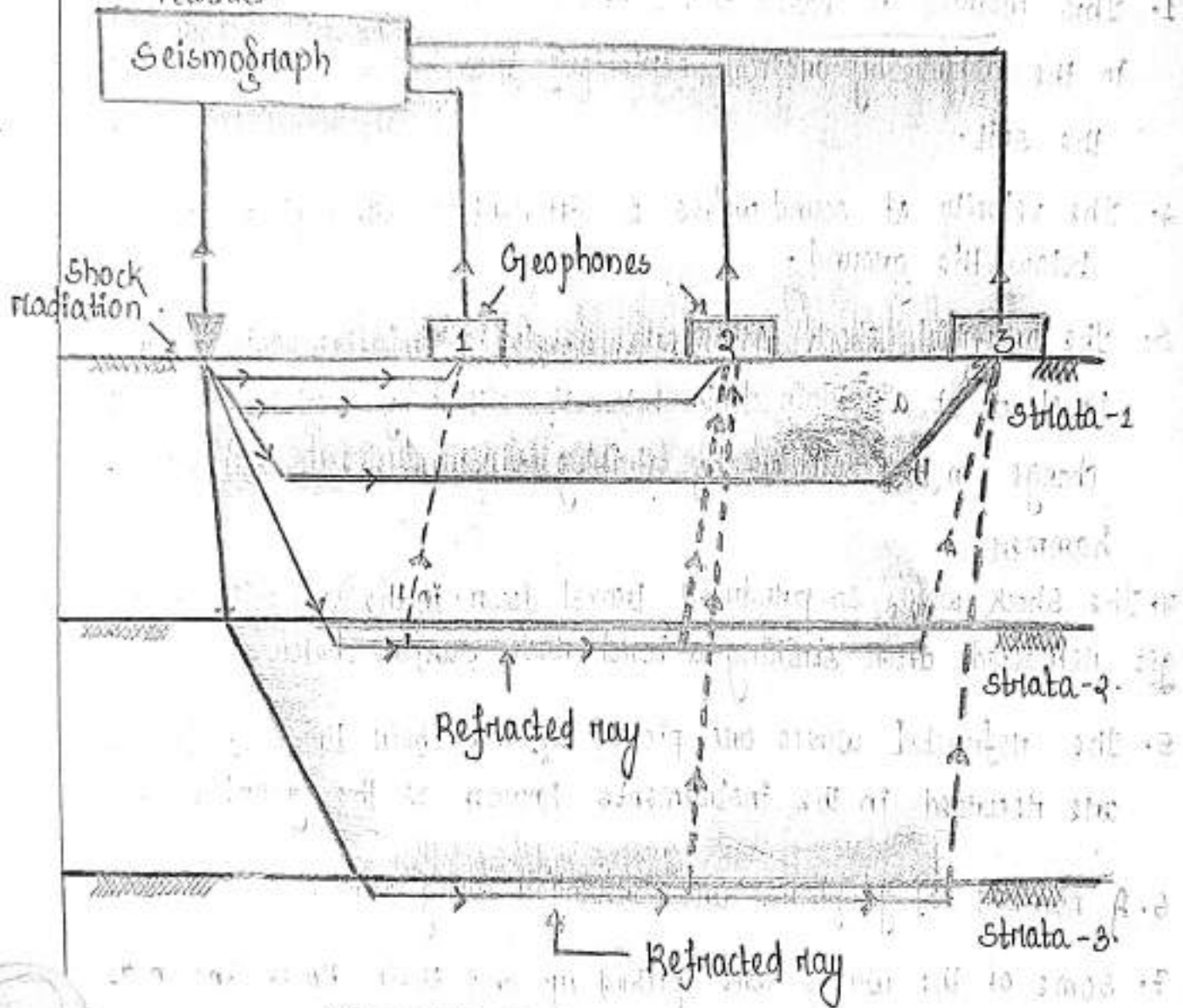

### SEISMIC REFRACTION METHOD

The seismic refraction method is used to determine the depth and velocity of subsurface layers. It involves measuring the travel time of seismic waves that have been refracted at the boundaries between different geological strata. The velocity of seismic waves increases with depth, and the refraction occurs at the interface between layers with different velocities. By analyzing the travel time curves, geologists can identify the different strata and their properties.



HOFFMAN'S CONTINUOUS KILNS

Principle - It is a modern and more refined type of brick kiln used for burning a large number of bricks and other clay products under controlled conditions of temperature.

Construction

1. In construction, Hoffmann's kiln consists of circular walled structure generally made over the ground.
2. The circular space enclosed in this way is commonly divided into 12 chambers by suitable partition walls.
3. The adjacent chambers are interconnected by communicating doors, which can be opened or closed by raising or lowering dampers.
4. A Hoffmann's kiln is also provided with a central chimney which is connected to all the twelve chambers through flues.
5. The flues can be closed or opened by dampers provided at the back of each chamber.
6. Each chamber is also provided with a separate gate in the outer wall through which it can be loaded, unloaded and fired.
7. The kiln has a permanent roof so that it can be worked throughout the year.

Working

1. At any given time, some chambers can be in the burning, others in the pre-heating, still others in cooling and some in the unloading stages.
2. In this process an upward draught or current of air within the kiln.

3. This is done by closing all the outergates except of the chamber which is being unloaded.
4. Natural air enters the kiln through the outergates to pass through different chambers by opening their interconnecting doors.
5. The flue at the back of each chamber is kept closed.
6. The air is then made to enter the chimney by opening the back flue of that chamber which is in pre-heating stage.

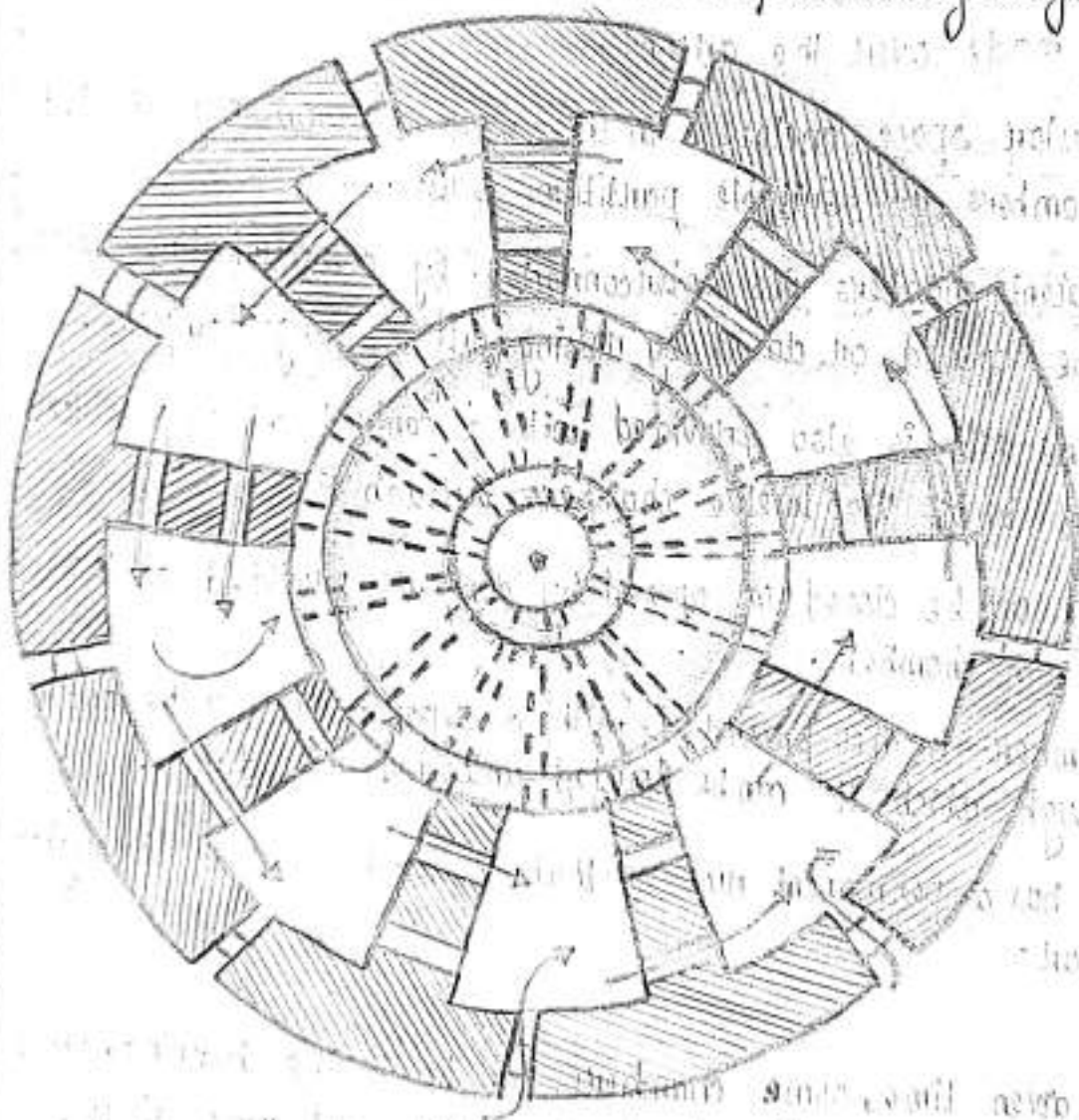

PLAN

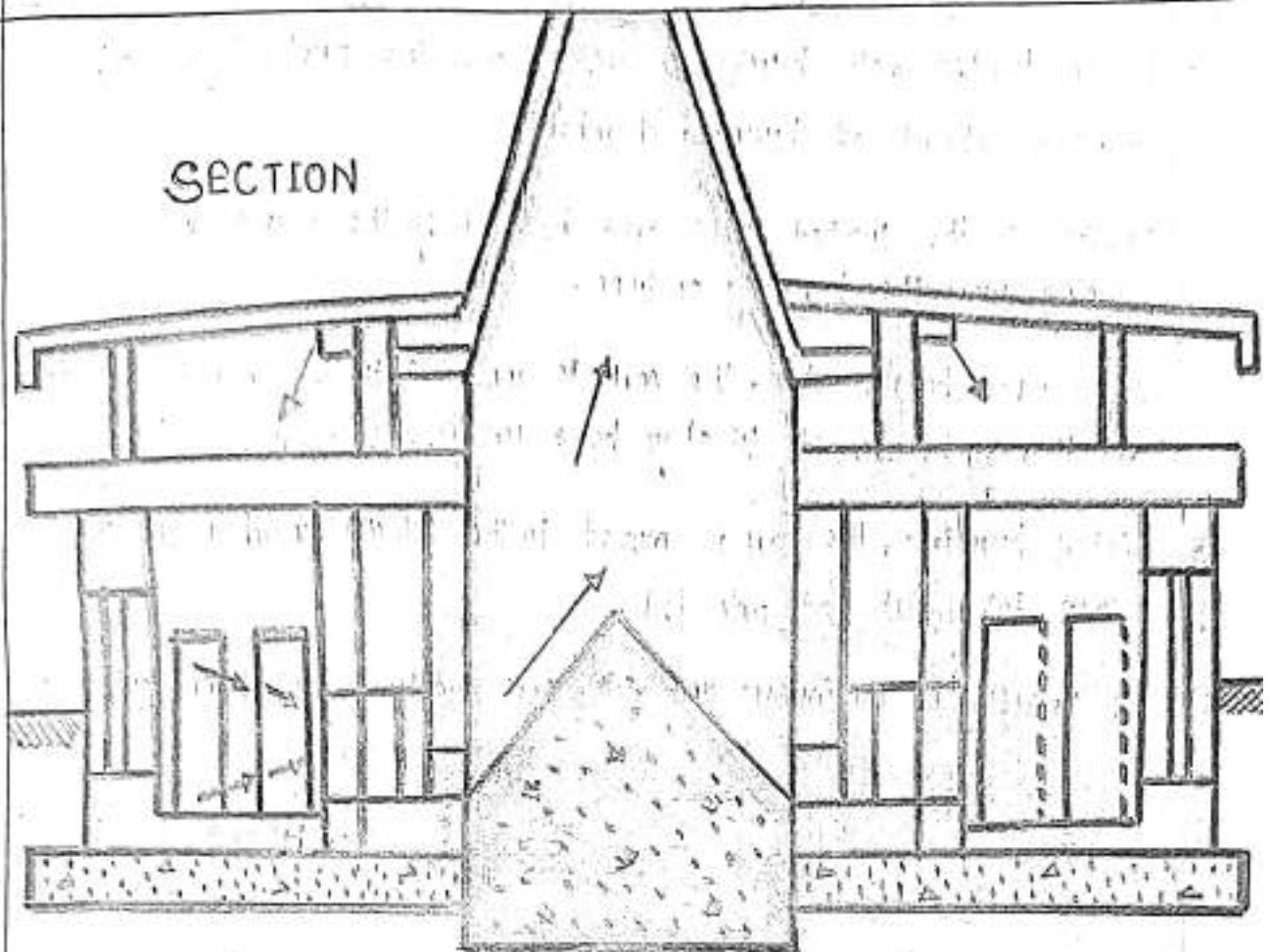

### TUNNEL KILN (continuous process)

1. It is a continuous type of kiln and is considered highly efficient.
2. It consists of a channel or tunnel 60 to 150 m long and 3 to 5 m wide and the tunnel is provided with rail tracks for cars.
3. The tunnel is divided into three sections for working
  - ① pre-heating section.
  - ② burning section.
  - ③ cooling section.
4. The flow and temperature of gases, humidity is kept under strict control in these sections.

### Working

1. It is a simple process for burning in kiln.

2. A cart loaded with bricks is moved into the preheating chamber which is ahead of burning chamber.
3. Bricks on the loaded carts are heated by the waste gases coming from the burning sections.
4. After a few hours stop, the cart is moved into the burning chamber and it may be allowed to stay here for 40-44 hours.
5. After burning the cart is moved to the cooling chamber and it is then taken out and unloaded.
6. The process is continuous and quick for supply of well burnt bricks.

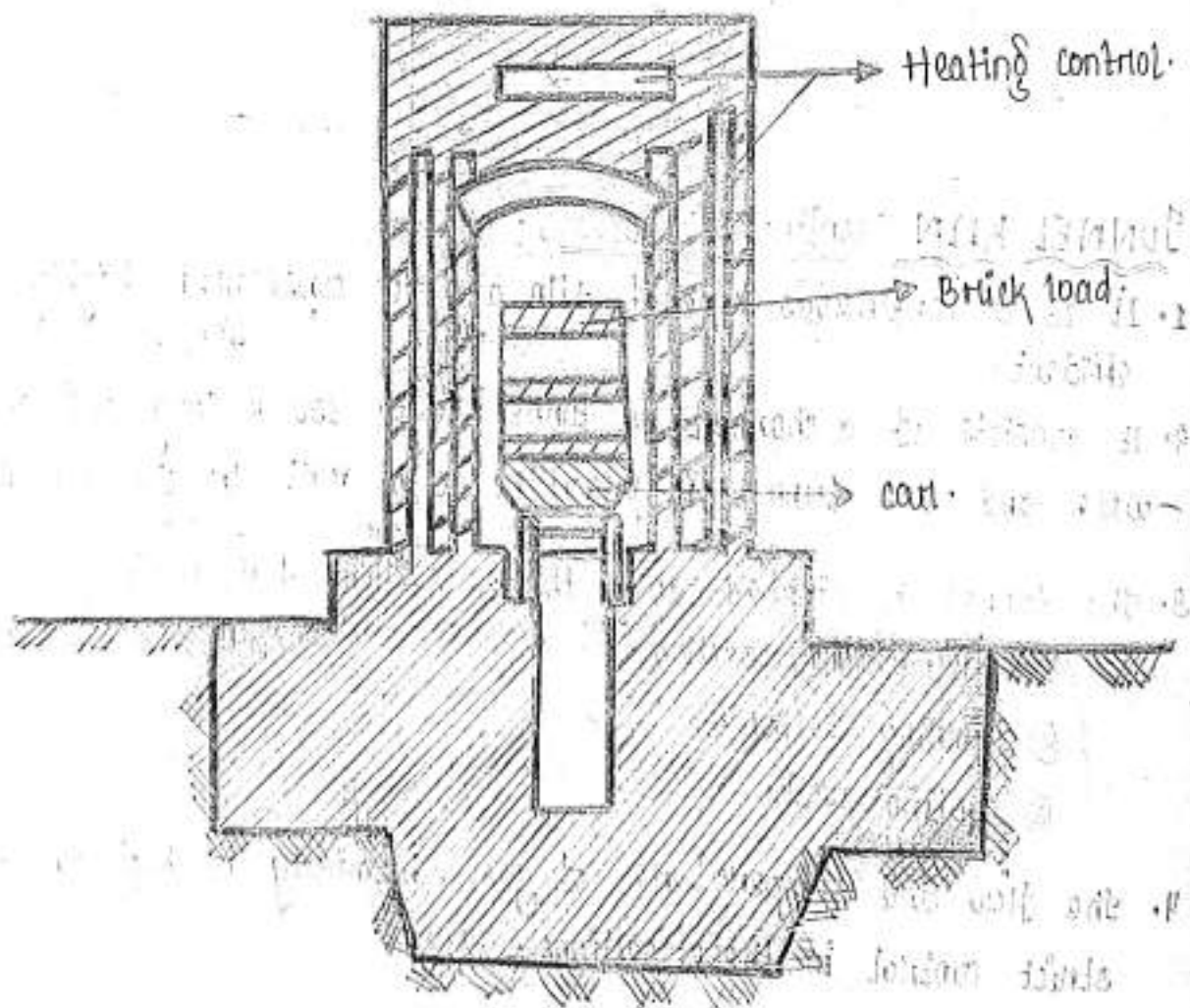

TUNNEL KILN

## FOUNDATION

### Shallow Foundation

1. The foundation can broadly be classified into two categories.
  1. shallow foundation ( $d \leq b$ ).
  2. deep foundation ( $d > b$ ).
2. If it is possible to construct foundations of a building at reasonable shallow depth, the foundation is called shallow foundations.
3. In shallow foundation, a spread is given under the base of a wall or a column and this spread is known as the footing and the foundation is known as spread foundation.
4. The footing contains steps or offsets and it is also called as stepped footing.
5. If the footing wall rests directly on foundation concrete without any step, it is known as the simple footing.
6. If slope is given to a footing, column or pier is called sloped footing.
7. In case of deep foundations, the piles are used to transmit the load of structure to the soil.

### Design of shallow foundation

- i) The total load to be transmitted by the wall or pier to the foundation bed.
- ii) The results of trial pits and the corresponding bearing capacity of each strata of soil.

## Classification of bricks

1. In every country, bricks have been divided into different classes on the basis of their properties.
2. According to BIS the classification of burnt bricks into following four main classes.

S.No	Class	Characteristics	Use
1.	First class Bricks.	<ul style="list-style-type: none"> <li>i) well burnt having even surface and perfectly rectangular shape.</li> <li>ii) when two bricks are struck against each other a ringing sound is produced.</li> <li>iii) Its compressive strength shall not be less than <math>140 \text{ kg/cm}^2</math> and its absorption after 24 hours immersion shall not exceed 4%.</li> <li>iv) It should show a uniform appearance, texture and structure when seen on fracturing.</li> </ul>	Excellent for all types of construction in the exterior walls when the plastering is not required. Also suitable for flooring.
2.	Second class Bricks.	<ul style="list-style-type: none"> <li>i) well burnt, even slight over burning is accepted.</li> <li>ii) Metallic-ringing sound is also a must in this case as well.</li> <li>iii) In shape, rectangular, but slight irregularity is permitted surface may be slightly uneven.</li> <li>iv) compressive strength shall not be less than <math>70 \text{ kg/cm}^2</math> and absorption value between 20 to 22%.</li> <li>v) slightly difference in structure on fractured surface is admissible.</li> </ul>	<ul style="list-style-type: none"> <li>i) For exterior work when plastering is to be done.</li> <li>ii) For interior walls. These bricks may not be used for flooring.</li> </ul>

	<p>i) poorly and unevenly burnt and may be over burnt or under burnt.</p> <p>ii) on striking dull sound is produced.</p> <p>iii) Appearance shape and size are also non-uniform and irregular.</p> <p>iv) compressive strength lies between 25 to 70 kg/cm<sup>2</sup> and absorption between 22 to 25%.</p>	<p>used mostly in ordinary type of construction and in dry situations.</p>
	<p>i) Irregular in shape and dark in colour, which is due to over burning.</p> <p>ii) Quite strong in compressive strength; generally above 150 kg/cm<sup>2</sup> and low in porosity and absorption.</p>	<p>These bricks are unfit for building construction. It has distorted shape and irregular size. It can be used in broken form in road construction, foundation &amp; floors as coarse aggregate materials.</p>

Size of traditional bricks.

- 9" x 4 1/2" x 3"

Size of standard modular bricks.

1. Actual size - 19 cm x 9 cm x 9 cm

2. Nominal size - 20 cm x 10 cm x 10 cm.

### Qualities of Good Building Bricks

1. It should have a rectangular shape, regular surfaces and red coloured appearance.

2. It should conform in size to the specified dimensions (19 cm x 9 cm x 9 cm).

3. It should be properly burnt. Holding two bricks freely one in each hand and striking them. A sharp metallic sound indicates good burning where as a dull sound indicate incomplete burning.

4. A good building bricks should not absorb water more than 20% of its dry weight. Absorption should not exceed 25% in any case.
5. A good building brick should possess requisite compressive strength which in no case should be less than 35 kg/cm<sup>2</sup>. A rough test for the strength, of the bricks is to let it fall freely from a height about one meter on to a hard floor. It should not break.
6. Brick should be hard enough so that it is not scratched by finger nail.
7. A good brick has a uniform colour and structure throughout its body. This can be checked by taking a brick from the lot and breaking it into two parts. The broken surface, in both the halves should have same appearance and structure.



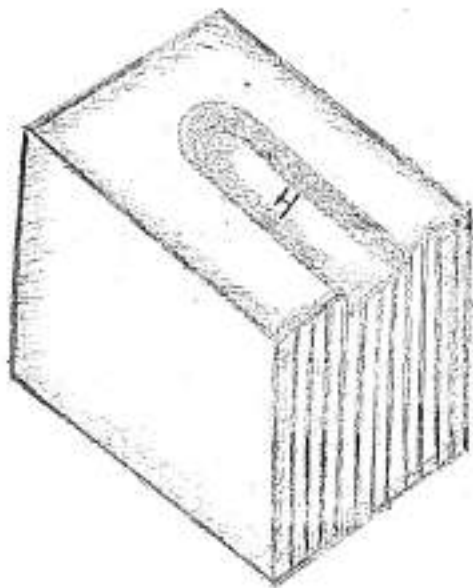
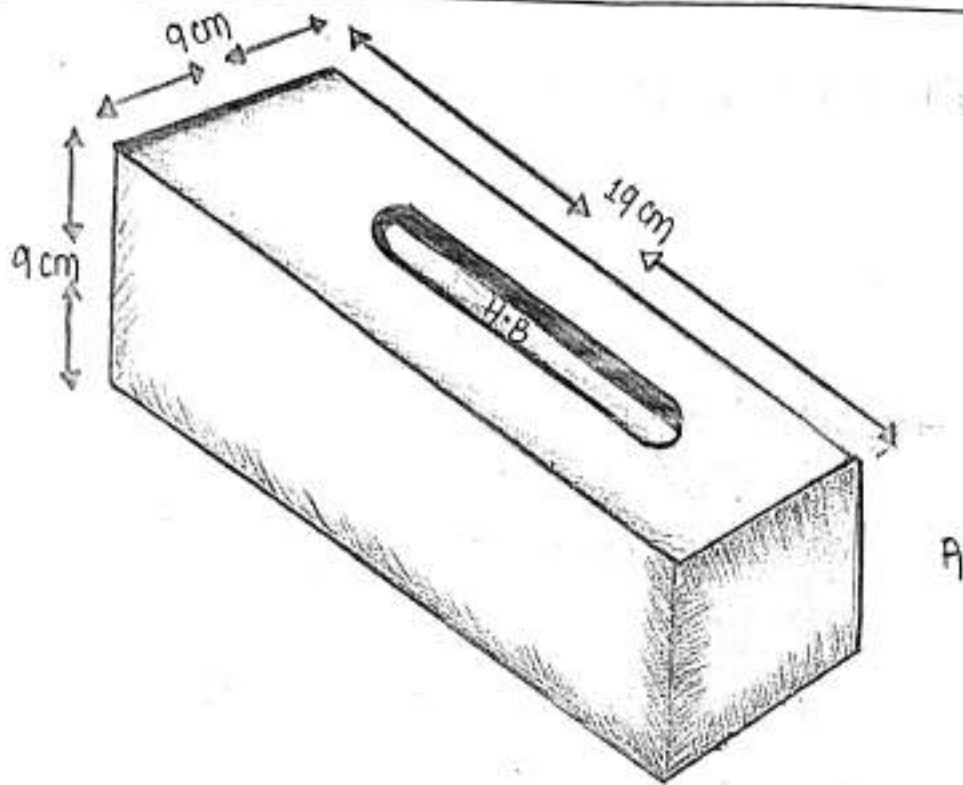

B

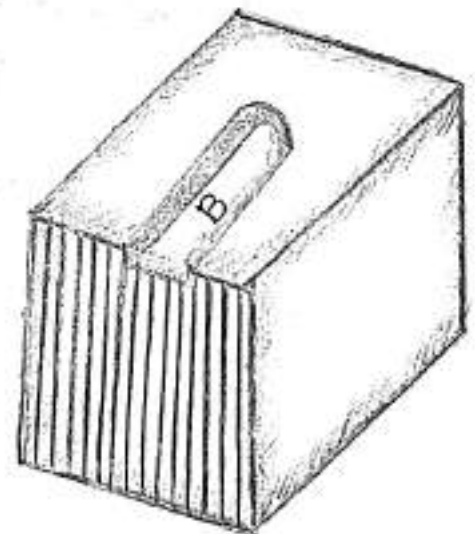

Qualities of a good brick.

(A) whole brick.

(B) two parts of a broken brick.

# DIMENSION TOLERANCE TEST

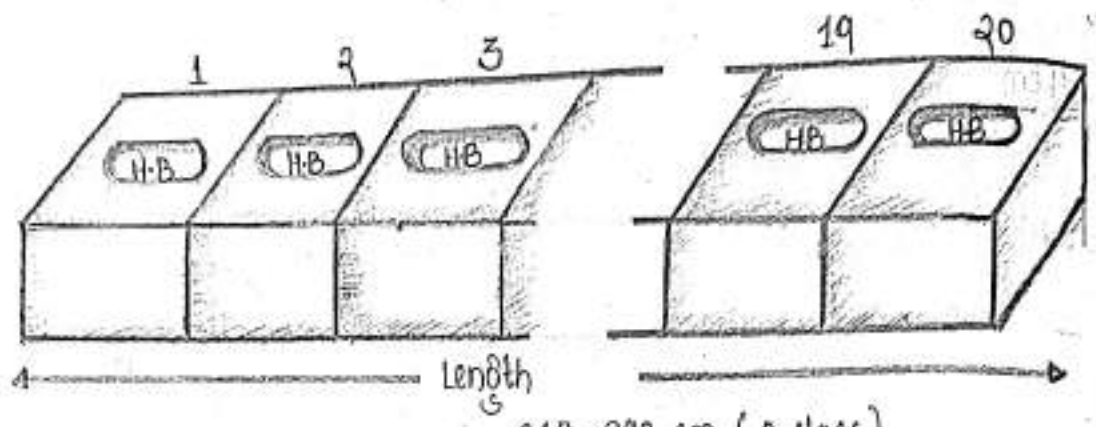

368-392 cm (A class)

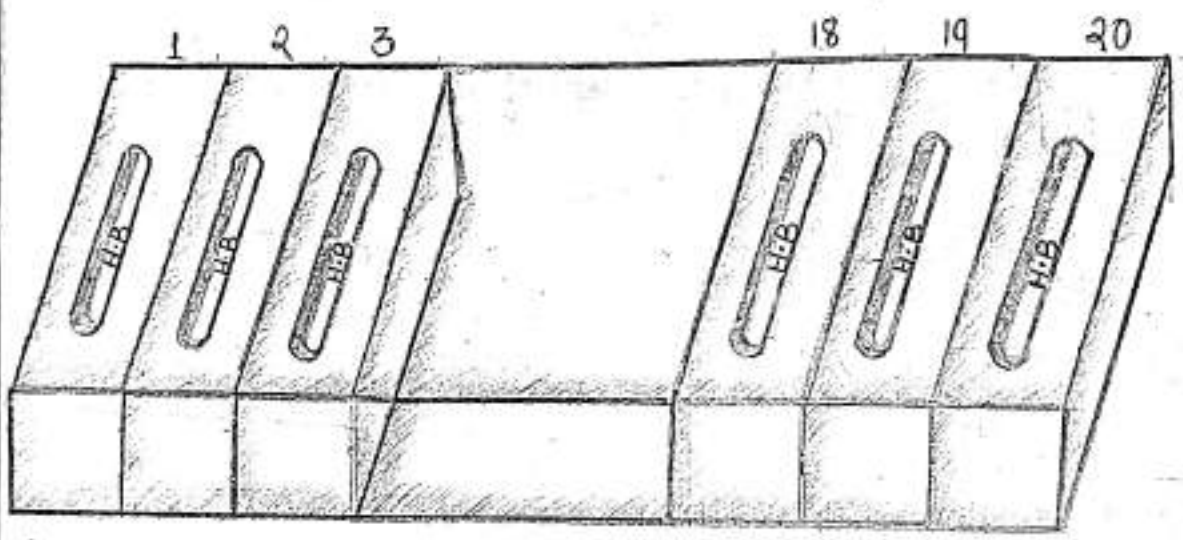

174-186 cm (A class)

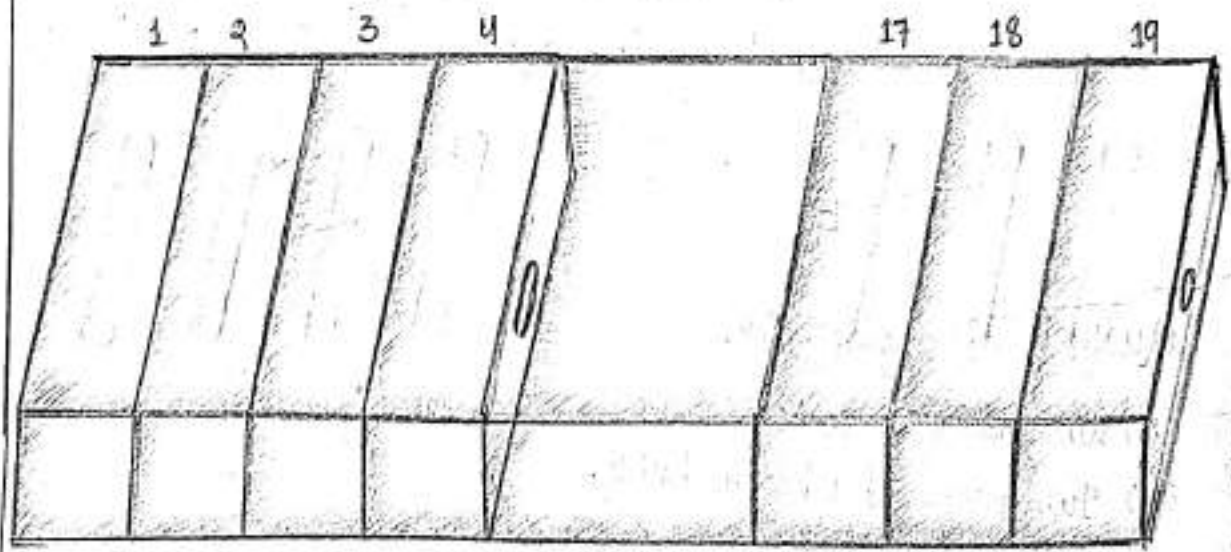

174-186 cm (A class)

CementTypes of cement

After ordinary portland cement (opc), a number of other types of cement are also manufactured by varying the ratio of the raw material or by adding some additional ratio of the raw material. Some special purpose cements are mentioned serially.

1. Rapid hardening cement.
2. Low-heat cement.
3. Quick setting cement.
4. High alumina cement.

After another group of cements primarily on the basis of raw materials used.

1. Blast furnace slag cement.
2. pozzolana cement.
3. white cement.

1. Rapid Hardening cement

Definition - 1. It is also known as high early strength cements.  
2. It attains maximum strength within 24 to 72 hours.

Properties

1. It contains relatively more tricalcium silicate.
2. This is done by adding greater proportion of limestone in the raw materials compared to that of opc.
3. It is more fine grained than the ordinary portland cement. Due to fineness of cement, it helps quicker and complete hydration during setting also gaining early strength.
4. The setting time for rapid hardening cement is same as ordinary port.

5. The extra fineness may be a cause of development of cracks.

### ② Low Heat-cement

Definition - It is a type of portland cement in which very low amount of heat of hydration is liberated during setting and hardening. This cement is mostly used in hard concrete structures w dam sand and pillars.

#### Properties

1. The proportion of dicalcium silicate ( $C_2S$ ) is increased to almost double than in ordinary portland cement.
2. The proportion to tetra calcium aluminoferrite ( $C_4AF$ ) is also increased to one and one half time than in ordinary portland cement.
3. The proportion of tricalcium silicate ( $C_3S$ ) and tri-calcium aluminate ( $C_3A$ ) are reduced by about 50 percent than in ordinary portland cement.

### ③ High Alumina cement

Definition - 1. It is special purpose cement which contains alumina in considerably large proportions (coverage 40%) than usual.

2. This cement is specially useful against corrosive action of seawater.

3. It is the most favoured cement for use in concrete structures in coastal areas.

#### Properties

1. It is greatly resistant to corrosive action of acids and salts of sea water.
2. The ratio of alumina to lime is kept between 0.85 and 1.30.

3. It is initial setting time (more than 3.5 hours), its final setting time is 5 hours. These setting characteristics give more time for working with high alumina cement.
4. Due to short final setting time the R.C.C structure against both tensile and compressive strength. It gains compressive strength of  $400 \text{ kg/cm}^2$  within 24 hours and  $500 \text{ kg/cm}^2$  after 72 hours.
5. It evolves great heat during setting.
6. It reacts quickly with force lime and ope so it should not be in contact with them.

#### ④ Quick setting cement

Definition - 1. After setting this cement gives stone like mass within a period of 30 minutes.

2. Quick setting is achieved by following control in manufacturing process is as below.

- i) The quantity of retarder like gypsum is reduced.
- ii) The quantity of alumina-rich components is increased.
- iii) The clinker is grinding to extreme fineness.

USE It is used for construction pillars and other structures in running and standing water.

The design of foundation can be considered in two ways.

1. width of foundation.
2. Depth of foundation.

## 1. Width of foundations.

The width of foundation is decided by adopting the following rules:

i) If no footings are to be provided to the wall i.e. for simple footing, the width of foundations should be equal to three times the thickness of wall.

ii) The total load including dead load, live load and wind load coming on the wall per meter length or in case of a pier, at the centre of the pier, is worked out. The width of foundation is obtained from the following relations:

$$\text{For walls, width of foundations} = \frac{\text{Total load per meter length}}{\text{allowable bearing capacity of the soil}}$$

$$\text{For piers, width of foundations} = \left[ \frac{\text{Total load on the pier}}{\text{allowable bearing capacity of the soil}} \right]$$

iii) Usually the walls and piers are given footings such that the width at the base becomes equal to twice the width of wall at the plinth level. By adding the width of foundations can be obtained for stepped footing.

1)  $t$  = thickness of wall.

$a$  = offset of concrete.

$$\text{width of foundation} = 2(t+a).$$

NOTE - The greater result obtained for rules (i) and (ii) should be adopted.

② Depth of Foundation :

The depth of foundations is obtained by keeping in view the following rules:

- i) As a general rule, all the shallow foundations should be taken to a minimum depth of 800 mm below natural ground level unless hard soil is available within 800 mm.
- ii) The total load to be transferred to the soil per square meter can be worked out and after the study of the results of the trial pits, the foundations should be taken to such a depth at which the soil has allowable bearing capacity greater than the above value.
- iii) The depth of foundations can also be obtained by drawing the lines of angles  $45^\circ$  and  $60^\circ$ .

Let  $d_1$  = Depth of the fillings.

$d_2$  = Depth of concrete block.

$d$  = Total depth of foundation.

Then,  $d = d_1 + d_2$ .

- iv) For loose soil, Rankine's formula can be used to find the minimum depth of foundations.

$$d = \frac{p}{w} \left( \frac{1 - \sin \phi}{1 + \sin \phi} \right)^2.$$

$d$  = minimum depth of foundation in meters.

$w$  = weight of soil in  $\text{kg/m}^3$  or  $\text{kN/m}^3$ .

$\phi$  = Angle of repose.

$p$  = load on the soil in  $\text{kg/m}^2$  or  $\text{kN/m}^2$ .

NOTE : This formula is used when the building to be constructed and rests on hard soil.

v) For finding out the depth of concrete block, the following formula can be used.

a) Depth of concrete block in cm =  $\frac{1}{58} \sqrt{\frac{pa^3}{m}}$

b) Depth of concrete block in cm =  $\frac{5t}{6}$

p = total load on foundation bed in kg/m<sup>2</sup>.

a = offset of concrete in cm.

m = safe modulus of rupture in kg/m<sup>2</sup>.

t = thickness of wall in cm above plinth level.

Note - None of the above (a) and (b) can be used for different foundation.

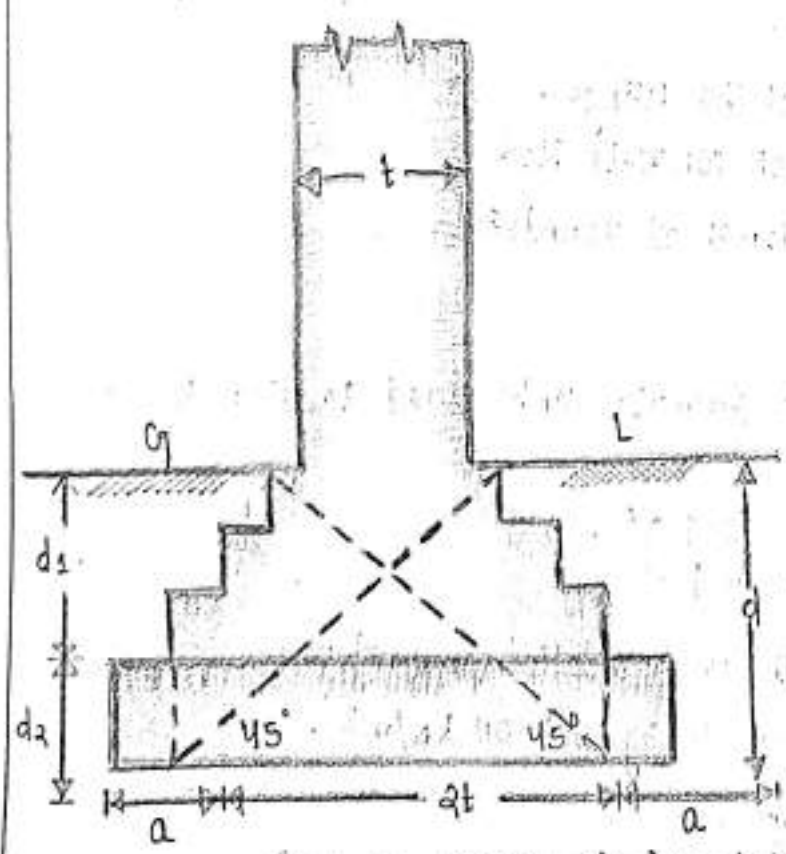

Depth of foundation



Depth of foundation

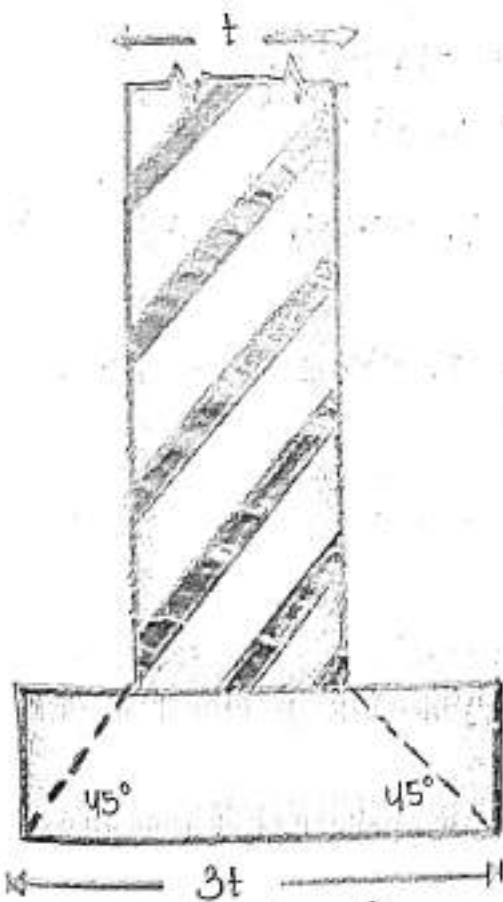
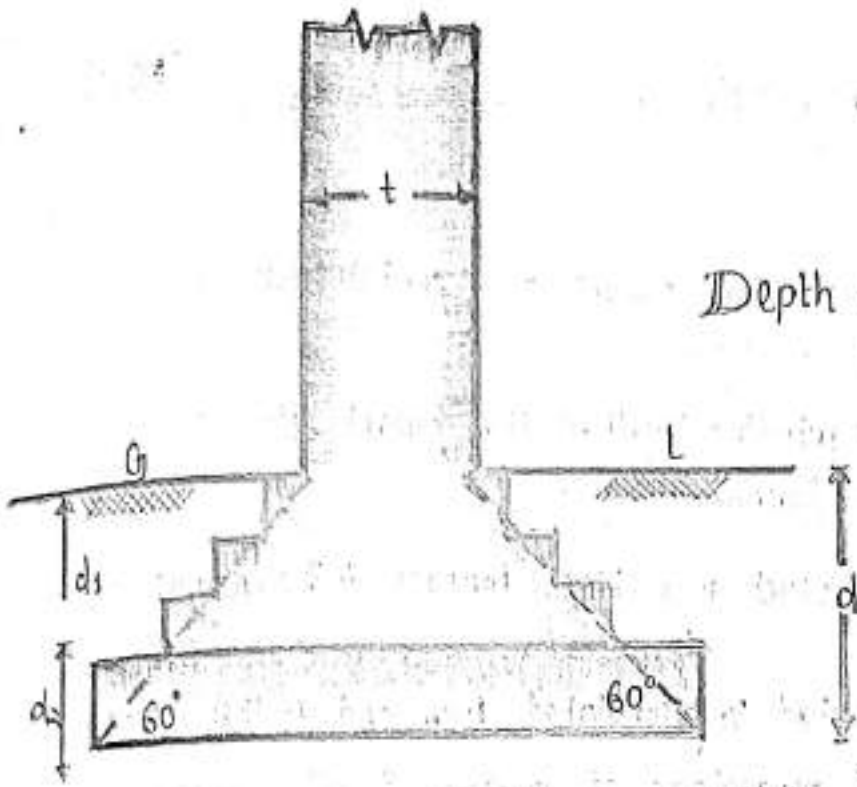

Simple footing

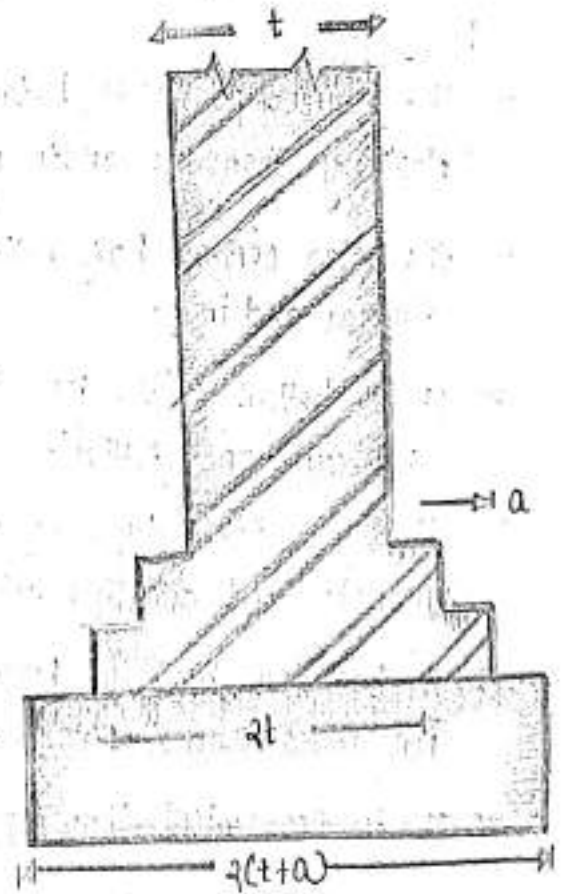

Stepped footing

Portland (Blast Furnace) Slag Cement.

Definition.

1. It is modified type of portland cement and contains 45 to 65 percent of blast furnace slag.
2. It is manufactured by grinding together the cement clinker with specific amounts of blast furnace slag.
3. The slag is a waste product from blast furnace in the manufacturing of iron.
4. The slag is first converted to granulated form and is then ground with clinker and small percentage of gypsum is also added for controlling the setting time of the slag.

Properties:

- i) The cement possesses better workability, cohesiveness and plasticity than the ordinary portland cement.
- ii) The slag cement has better resistance to sulphate of alkali metals, alumina and iron.
- iii) It is better suited for use in marine structures as in docks, harbours and jetties.
- iv) It is an ideal type of cement for use in road construction in marshy and alkaline soils.
- v) It has low heat of hydration. This property makes it useful for mass concrete work.
- vi) It is economical than ope.

Pozzolana cement

Definition - 1. In this type of cement, clinker has been mixed with definite proportions of pozzolanic material such as volcanic ash, flyash, powdered burnt bricks.

2. pozzolanic material react with cement compound and form components having cementing properties.

### Properties

- i) It produces less heat of hydration and used for mass concrete work.
- ii) It offers great resistance to sulphate and corrosive action of a water. It is also suitable for use in work and for under water construction.

### coloured cement

Definition - 1. Any desired colour can be mixed to the portland cement by mixing with it a definite proportion of a mineral pigment.

2. It is generally less than 10% by weight, and most commonly between 2 to 5%.

pigments used for coloured cements are.

- i) Chromium oxide for green colour.
- ii) cobalt for blue colour.
- iii) Manganese dioxide for black and deep brown colour.
- iv) Iron oxide for various shades of red, brown and yellow colour.

USE Coloured cements are extensively used for top coat in flooring and for decorative purpose in various places in a building.

White cementDefination ÷

1. It is a special type of cement which on use gives milky or snow and white in appearance.
2. White cement is manufactured from pure lime stone (chalk) and clay that are totally free from oxides of iron, manganese and chromium.
3. The kiln is fired by oil rather than by coal to avoid any contamination.

Properties

1. It has properties of strength and setting times and similar to ordinary portland cement.
2. It is costly and used in selective area of construction.

Hydrophobic cement

Defination ÷ 1. It is a special type of cement containing admixtures which reduce the cement grains for water.

2. It is costly and used in soap and acidol are generally added to achieve this property.

USE: This cement are specially useful for application in cold, frost forming conditions.

Super sulphate cement

Defination: 1. This variety of cement is manufactured by adding qualities of calcium sulphate and blast furnace slag to the ordinary portland cement.

2. It is economical.

USE: This cement are specially useful for application in cold, frost forming conditions.

### Low Alkali cement.

1. Where there is silica in concrete as aggregate use of low alkali cement is recommended.
2. It is portland cement but alkali content is kept low while manufacturing and a very strict control over the composition of raw materials used.

### Methods of Manufacture

Portland cement is manufactured by two processes.

1. Dry process.
2. Wet process.

#### Dry process

In the dry process calcareous and argillaceous raw materials are fed into the burning kilns in a perfectly dry state.

In the wet process the above materials are supplied to the kiln in the form of a mixture with water called slurry.

#### Steps in the process of manufacture:

1. Treatment of raw materials.
2. Burning of dry mix.
3. Grinding of the clinker.
4. packaging and storage.

#### 1) Treatment of Raw materials:

The raw materials limestone and clay are subjected to such processes as crushing drying, grinding, proportioning and blending or mixing before they are fed to the kilns for calcination or burning.

↳ The crushing stage - involves breaking the raw materials to small fragments that vary in size between 6 to 14 mm. Machines called crushers are useful for this purpose.

iii) The drying stage is typical of the dry process. Drying of crushed materials is essential and is achieved by heating these materials (separately) at temperatures sufficiently high to drive out uncombined water. Heating is done in drying kilns which are generally of rotary type.

iv) The grinding of each materials as obtained from the driers is done in two stages.

First, the preliminary grinding in which the materials are reduced to a fineness of 50 mm mesh. Ball mills are generally used for preliminary grinding.

Second, the fine grinding in which the size of the material is reduced to 200 mm mesh. This is done by grinding in tube mills.

Each raw materials is then reduced to a required degree of fineness and is stored separately in suitable storage tanks called silos or bins where from it can be drawn out conveniently in requisite quantities.

v. Proportioning and Blending - predetermined proportions of finely dried and ground raw materials are mixed together before they are fed into kiln. The different materials then combined together are mixed thoroughly either by mechanical or by pneumatic method.

Mechanical method - Materials from different storage silos are simultaneously drawn off and fed into a single silo that now contains mixed materials.

Pneumatic method - Dry proportional materials are pumped under pressure in a blending silo, where from they are drawn

in the mined state. The blending materials and then ready for feeding into the burning kilns from this stage onwards, there is practically no major difference between the dry and wet process, except in the design of the rotary kiln.

See the vital sectional view of

1. Rotary kiln.
2. Ball mill.
3. Tube mill.

A.

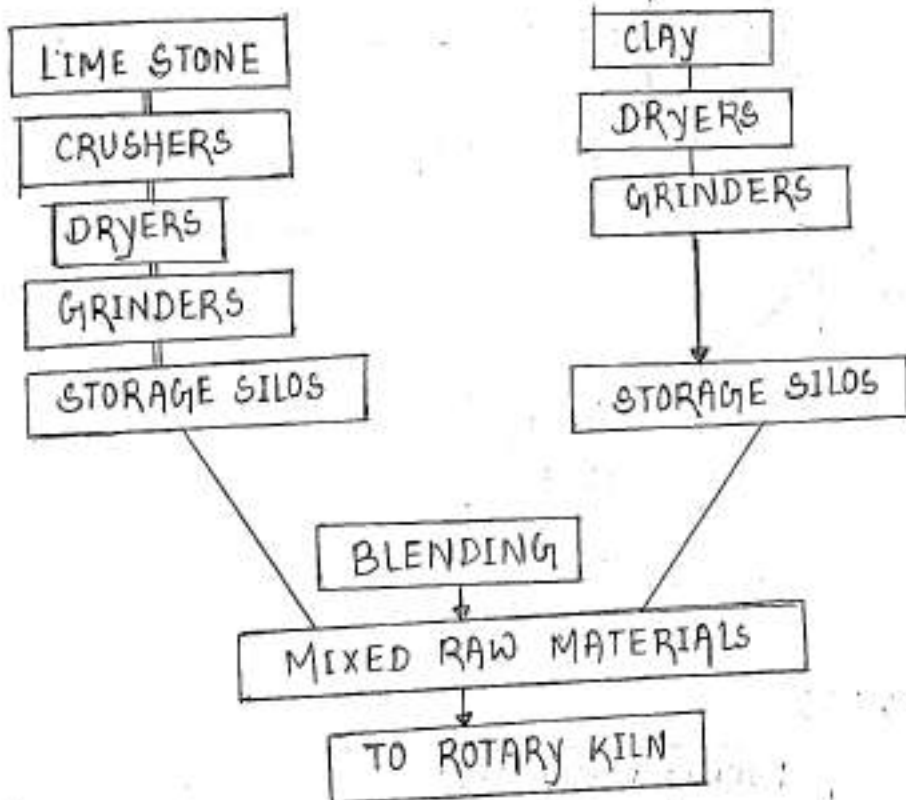

DRY PROCESS

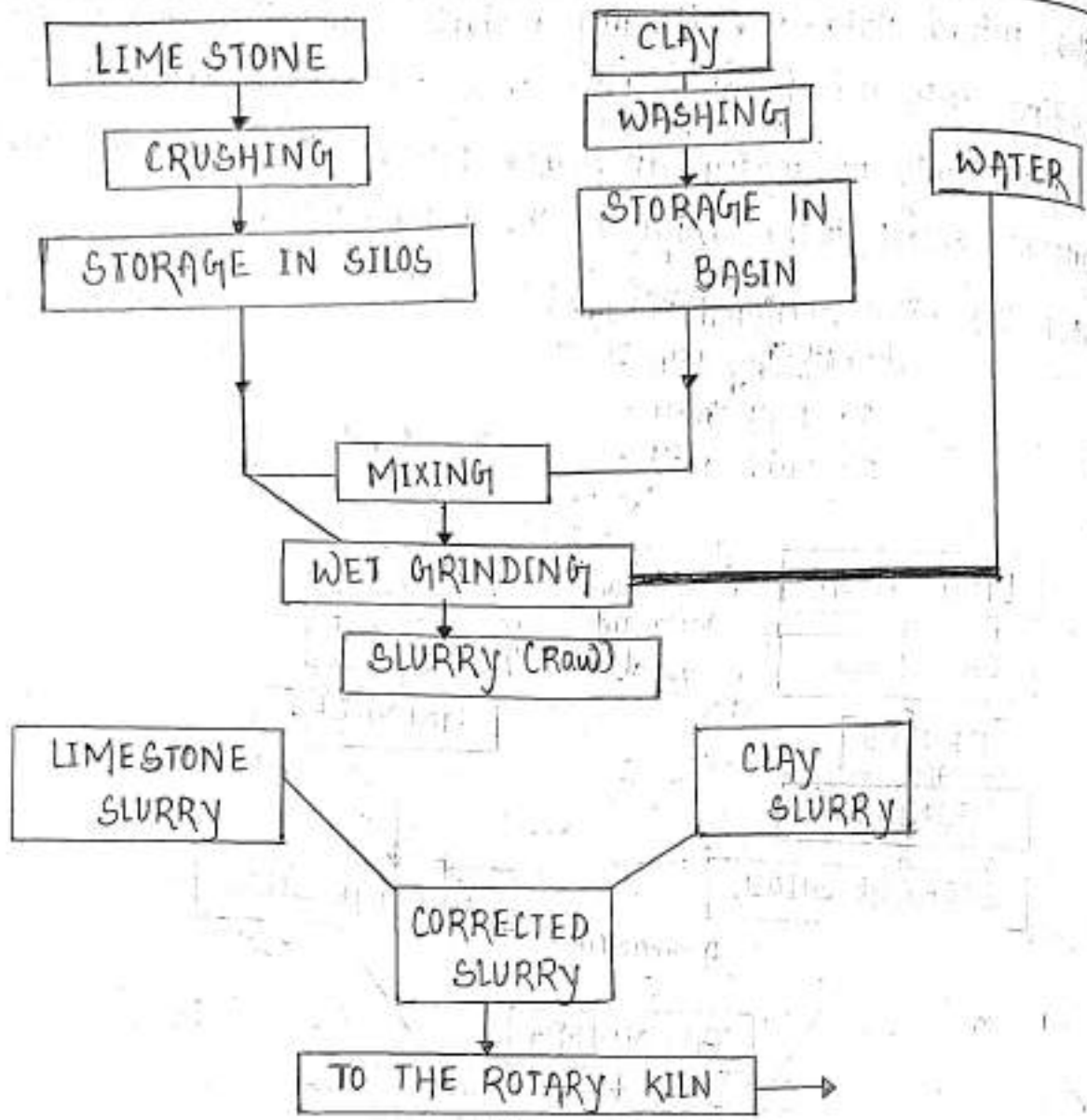

B. WET PROCESS

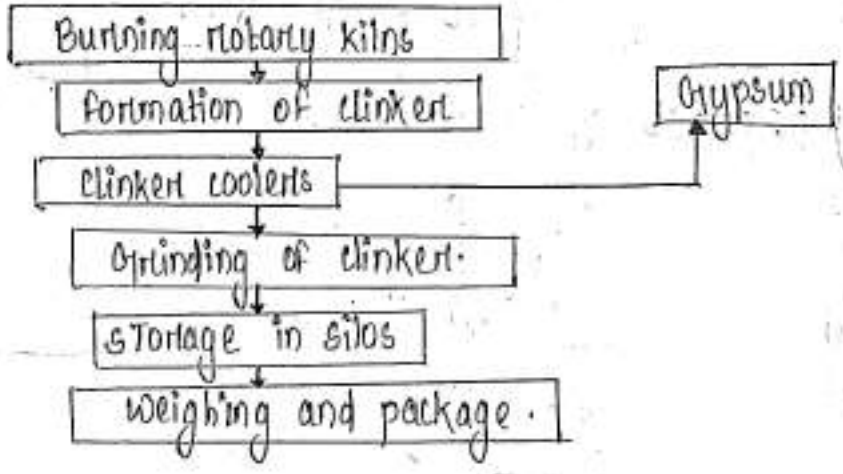

c. Cement manufacture.



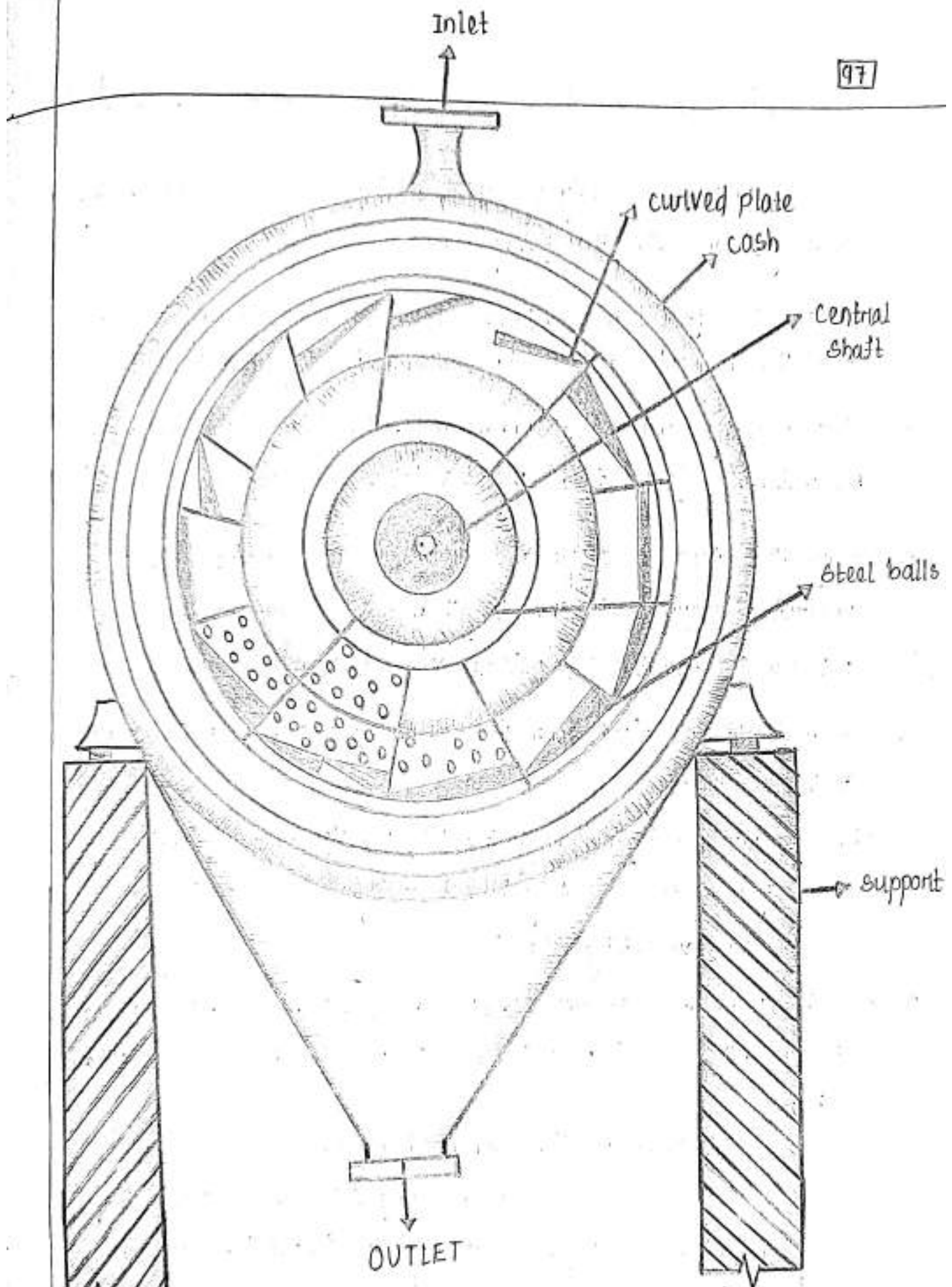

Outline sketch of a Ball Mill (vertical section).

Burning or calcination

1. The well proportional finely powdered mixture is charged in to long steel cylinder called the Rotary kiln.
2. The kiln is adjusted in a inclined position, making an angle of 15 with the horizontal and rotates around its longer axis.
3. It has a charge end and a burner end, the former for introducing the materials (called feed) and the latter for supplying fuel.
4. Rotary kilns differ in design and dimensions in accordance with the production requirements. The length may be 100 to 180m and 3 to 5m in diameter also rotation of 60 to 90 revolutions per hour.
5. Coal in finely pulverized form fuel oil and gas are common fuels used in these kilns.
6. The raw mixture is burned in the kiln the full proper burning is achieved. This is indicated by its taking a greenish black colour and vitreous or shining like glass.
7. This burnt material is called clinker is cement in composition but not in size. It is about walnut-sized lumps when it comes out of the kiln.
8. The following three reactions during burning.
  - i) complete dehydration - water is completely driven off at the very initial stage of burning at temperature as low as  $400^{\circ}\text{C}$ .

ii) Dissociation of carbonates.

Carbonates of calcium and magnesium are completely dissociated at temperatures between  $800^{\circ}$  to  $900^{\circ}\text{C}$ .

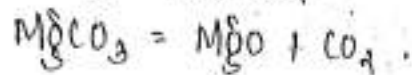
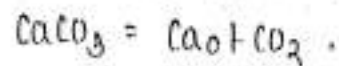

iii) Compound formation - i) lime and magnesium as formed are combined in the next stage with silica, alumina and ferric oxide to form the basic compounds of cement namely, tricalcium and dicalcium silicates tetra calcium alumina ferrite also tricalcium aluminates.

ii) These compounds formation reactions start at temperature around  $1200^{\circ}\text{C}$  and required temperature as high as  $1550^{\circ}\text{C}$  for their completion.

iii) It is taken place near the burner end of rotary kiln and alkalies, moisture and harmful gases are expelled out as water vapour during the burning of the raw materials of the kiln.

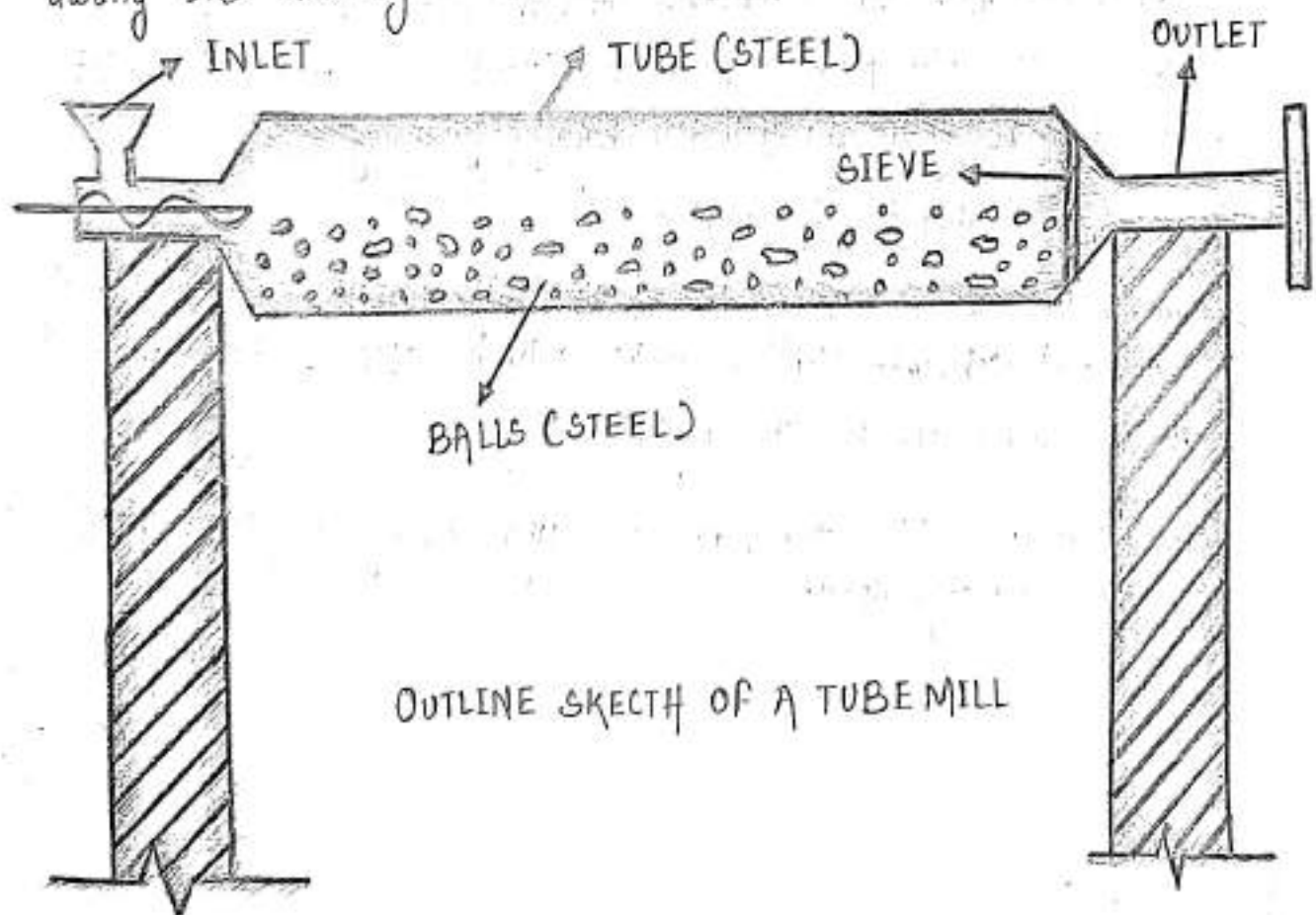

### 3. Grinding of the clinker.

1. The completely burnt or calcined raw materials of cement are obtained in lump-shaped product, called clinker which is collected at the lower end of the rotary kiln. It is extremely hot then first cooled in clinker cooler. Gypsum ( $\text{CaSO}_4 \cdot 2\text{H}_2\text{O}$ ) is added to the cooled clinker and sent for pulverizing.

2. In pulverisorts the mixture is reduced to an extremely fine powder by grinding it in two stages:

1. preliminary grinding

2. fine grinding

• preliminary grinding is achieved by using gyratory type of crushers.

• fine grinding of mixture by submill and the tubemills are provided with air-separators through which material of desired fineness can only pass and coarser portion of material cement is fed back into the mill for further grinding.

### Packing and storage of cement.

1. cement is most commonly stored after its manufacture in specially designed concrete storage tanks called SILOS, where from it is drawn off for the market in bags.

2. For cement packing cloth, jute and high density, polythene (HDPE) are commonly used.

## Deep foundation.

(pile foundations).

cohesive soil - It is defined as sticky soil and can be known as clay or silty clay. The surface tension of capillary water exerts the capillary forces, which reduces the soil strength.

Example - silt, clay, loam and laterite.

Non-cohesive soil - It is free running type of soil, such as gravel or sand whose strength depends on friction between soil particles.

### Other property of cohesive soil.

1. cohesive soils are black cotton soil or fine soils.
2. cohesive soils are having property of expansive or shrink.
3. The black cotton soil is serious problem for geotechnical engineers and it is required to be treated before the construction of superstructure.

## Pile foundation.

1. In case of deep foundation, the piles are used to transmit the load of structure to the soil.
2. construction for the foundation of a wall or a pier, which is supported on the piles.
3. The piles may be placed separately or they may be placed in the form of a cluster throughout the length of the wall.
4. pile is adopted when the loose soil extends to a great depth.
5. The load of the structure is transmitted by the piles to hard stratum below or it is resisted by the friction developed on the sides of piles.

6. piles are relatively long, slender members and are either driven into the ground or bored cast in situ.
7. It is used when the soil is weak and not able to withstand superstructure load meeting, the desired criteria of satisfactory foundation i.e. no shear failure of the foundation soil and not exceeding the allowable settlement.

### Selection of pile

pile selection depends upon soil condition and the type of piles. i.e. a driven pile or a cast-in-situ-pile, selection will be depends upon soil type and its consistency if cohesive soil and degree of compaction of cohesionless soil.

### Wet process

1. It is considered a better and convenient process for the manufacture of cement where limestone of soft variety is available more in quantity.
2. The processes are in three headings.
  1. preparation of slurry.
  2. calcination.
  3. Treatment of clinker.

### ① preparation of slurry

- i) In wet process, raw materials are supplied to the kiln in the form of mixture with lot of water in it. This is called SLURRY.
- ii) To obtain SLURRY of a standard composition, the raw materials are first crushed separately using crusher for limestones and grinding mills (wet) for clays.

- iii) These crushed materials are stored in separate tanks or silos.
- iv) They are drawn from the silos in pre-fixed proportions into the wet grinding mills where in the presence of a lot of water, these get ground to a fine thin paste.
- v) This is stored in third silos called the SLURRY BILD.
- vi) Its composition is tested once again and corrected by adding limestone slurry and clay slurry in required proportions.
- vii) The corrected slurry is then fed into the Rotary kiln.

### ② Calcination or Burning

1. For burning of the slurry, a rotary kiln of almost similar type is used as described in dry process.
2. The length of the drying zone is larger, because the material is fed into the kiln with more water.
3. All the moisture is driven off from the slurry in drying zone and the further process are same as in dry method of processing.

### ③ Grinding of clinker

1. Lump shaped clinker comes out from the kiln which is hot and then passed through air cooler rotary cylinders.
2. Gypsum (2 to 4%) added and ground to fine powder as in dry process.
3. Then the cement is packed same as dry process.

#### Types of piles.

1. Load bearing piles.
2. Non-load bearing piles.

### Load bearing piles.

1. These piles bear the load coming from the structure.
2. The piles are generally driven vertically or in near vertical position.
3. When a horizontal force is to be resisted the piles may be driven in an inclined position is known as batter pile.
4. It can resist horizontal forces.
5. If batter piles are used together with vertical piles, a part of vertical load will be transferred to the batter pile.
6. The load bearing piles may resist the load by directly resting on a firm stratum or by friction developed at their sides.
7. The load bearing piles are known as bearing or sustaining piles and friction piles are known as friction or floating piles.

### Non-load bearing piles.

1. These piles are separate from load bearing piles and not designed to take any vertical load.
2. It is designed to carry horizontal earth pressure and such piles are known as sheet piles.

### DEEP FOUNDATION

(pile foundations).

#### Uses of piles:

- The situations which demand piles as foundations are as follows.
1. The load coming from the structure is very heavy and the distribution of load on soil is uneven.
  2. The subsoil water level is likely to rise or fall appreciably this may be seasonal or occasional variation.



- ii) The pumping of subsoil water is too costly for keeping the foundation trench in dry condition.
- iv) The construction of raft or grillage foundations is likely to be expensive or is practically.
- v) The firm bearing stratum exists at a greater depth. The piles up to 30 metres depths are common and under exceptional circumstances, they may even be taken to 30 metres depth. The piles are considered to be long which their length exceeds 30 metres.
- vi) The shoring to excavations is too difficult to maintain the sides of the foundation trench.
- vii) The pile foundation is to be adopted for the structures in the area where canals, deep drainage lines are to be constructed in near future.
- viii) The structure is situated on sea-shore or river bed and the foundation is likely to be affected by the scouring action of water so piles are useful for the marine structures.
- ix) The piles are allowed as anchors. They may be designed to give lateral support or to resist an upward pressure or uplift pressure.
- x) The piles are used as tender piles in the construction of docks pier marine structures. A tender protects the bearing from damage.

## Materials used in construction of load bearing pile.

1. cast-iron piles.
2. cement concrete piles.
3. sand piles.
4. steel piles.
5. timber piles.
6. wrought-iron piles.

### 1. cast iron piles.

1. It is hollow.
2. The inside dia of pile is about 300 mm and thickness is about 25 mm.
3. The length of pile is about 3 metres to 4 metres and with the help of suitable device, it can be extended to any desired length.
4. cast-iron is brittle so it is not possible with the help of hammer.
5. special screws are provided at the bottom of piles and then driven like a screw into the ground. These are known as the cast-iron screw piles.

### 1. Advantages of cast-iron piles.

- i It is useful for dress where the timber piles will be attacked and damaged by the insects or worms.
- ii It is suitable for heavy vertical pressure.
- iii If shocks or vibrations would endanger the adjacent properties, the cast-iron piles are to be preferred.

### 1. Disadvantages of cast-iron piles.

- i It can't resist shocks or vibrations.
- ii It can't use under sea water.

### 2. Cement concrete piles.

- i It possesses excellent compressive strength.

iv Now a days, RCC piles becoming more popular and these piles are just replacing piles of other materials.

iii It is divided into two groups.

1. cast-in situ concrete piles.

2. pre-cast concrete piles.

### Cast-in-situ concrete piles.

1. In this type of concrete piles, a bore is dug into the ground by installing a casing.

2. This bore is then filled with cement concrete after placing reinforcement.

3. The casing may be kept in position or it may be withdrawn.

4. The former piles are known as the cased cast-in-situ concrete piles and the latter piles are known as the uncased cast-in-situ concrete pile.

5. The various process of cast-in-situ concrete piles.

i) cased cast-in-situ concrete piles.

ii) uncased cast-in-situ concrete piles.

### Cased cast in-situ concrete piles.

1. In this method the casing is vertical, straight and undamed.

2. It is costly because the casing is to be kept along with the pile.

3. The casing protects the freshly placed concrete against ground pressures, intrusions and movement as the concrete sets.

4. The shell lengths are easily adjusted on the job during the installation process to suit the changing subsoil.

Examples of cased cast-in-situ concrete piles are.

i) Raymond piles.

v) esp base driven piles.

ii) Mac Arthur piles.

vi) sewage piles.

iii) Monotube piles.

vii) bottom-bottom piles.

iv) cast pneumatic mandrel piles.

## Construction Technology.

### Types of cased cast-in-situ concrete piles.

#### 1. Raymond pile.

In 1847, A.A. Raymond developed a practical and economical way of placing cast-in-situ concrete piles and the system is known as Raymond pile system.

Following two types of Raymond piles are in common use.

#### a) Raymond standard concrete pile. (Fig-7.1)

1. It consists of a thin corrugated steel shell closed at bottom.
2. The shell is driven into the ground with a collapsible steel mandrel or core in it.
3. When the desired depth is reached, mandrel is collapsed and withdrawn.
4. The shell is then inspected internally by using the light from a mirror or flashlight or drop light.
5. If the shell is found to be damaged during driving, it is replaced by another shell.
6. The concrete is then poured in the shell to finish up the pile.
7. The tip dia is about 200mm and spirally wound wires are provided at 80mm pitch to serve as reinforcement.

#### b) Raymond step-taper concrete pile. (Fig-7.2)

1. It consists of shell sections of suitable length.
2. The bottom of first shell to be driven is closed by a flat steel plate.
3. The diameter of pile increases in steps at the rate of 45mm for each successive shell section.
4. The required length of pile is obtained by joining the proper no. of sections by screw connections.

5. Rest process is same as Raymond standard concrete piles.

② Mac Arthur piles (fig - 1.3 to 1.5).

1. In this type of piles, a heavy steel casing with a core is driven into the ground.
2. When the desired depth is reached, the core is withdrawn and a corrugated steel shell is placed in the casing.
3. The last operation consists in filling and gradually compacting the concrete and withdrawing the casing.

③ Monotube piles

1. A monotube pile consists of a tapered fluted steel shell without mandrel.
2. The pile shells are driven to the required depth and then, the interior of the shell are inspected.
3. The shell is then filled with concrete and the excess shell, if any, is cut off.
4. The extension of shell up to the required length is carried out by the welding.
5. The shells are rigid and water tight.
6. These piles are helpful, where there is less bearing capacity of soil and friction in soils.

④ Cole pneumatic mandrel piles.

1. When in loose state, the diameter is about 30 mm smaller than that of the shell diameter.
2. The mandrel is placed in the shell and then nitrogen or air is forced into the mandrel at a pressure of about  $9 \text{ kg/cm}^2$  or  $0.90 \text{ N/mm}^2$ .
3. After that the mandrel becomes tight with the shell.
4. Both the shell and mandrel is then lowered to the required depth.

5. The valve of mandrel is then opened and nitrogen or air is allowed to escape.

6. The mandrel collapses and it can then be withdrawn.

7. The concrete is then fill up in the shell.

### ⑤ Bsp base driven piles.

1. This pile consists of a helically welded shell of steel plate:

2. A concrete plug is provided at the bottom of the shell and driving is done by allowing pile hammer to fall on the concrete plug.

3. The casing is driven to the desired depth and then it is filled with the concrete.

4. The casing is driven to the desired depth and then it is filled with the concrete.

### ⑥ Savage pile. (Fig-7.7 to 7.9)

In this pile, a pre-cast concrete plug of slight conical shape provided at the bottom of a steel shell.

There are three stages of forming these piles.

1st stage - The shell and core are fixed at the top and driven on the top of concrete plug.

2nd stage - The core reaches the top of concrete plug and the shell is forced round the taper of the plug forming a water tight joint.

Final stage - At the end remove the core and filling the shell with concrete.

These piles are used for hard soils or at places where there is watertight shells before concrete is placed in the shell.

### ⑦ Button-bottom piles. (Fig-7.10 to 7.12)

In this pile, a concrete button is used at the bottom to provide an enlarged hole in the soil when the pile is being driven.

These are three stages of forming these piles.

1st stage - The steel pipe is set on the concrete button.

2nd stage - The pipe and button are driven up to the required depth and a corrugated steel shell is inserted inside the steel pipe.

Final stage - The pipe is withdrawn and concrete is fill up after placing reinforcement is necessary.

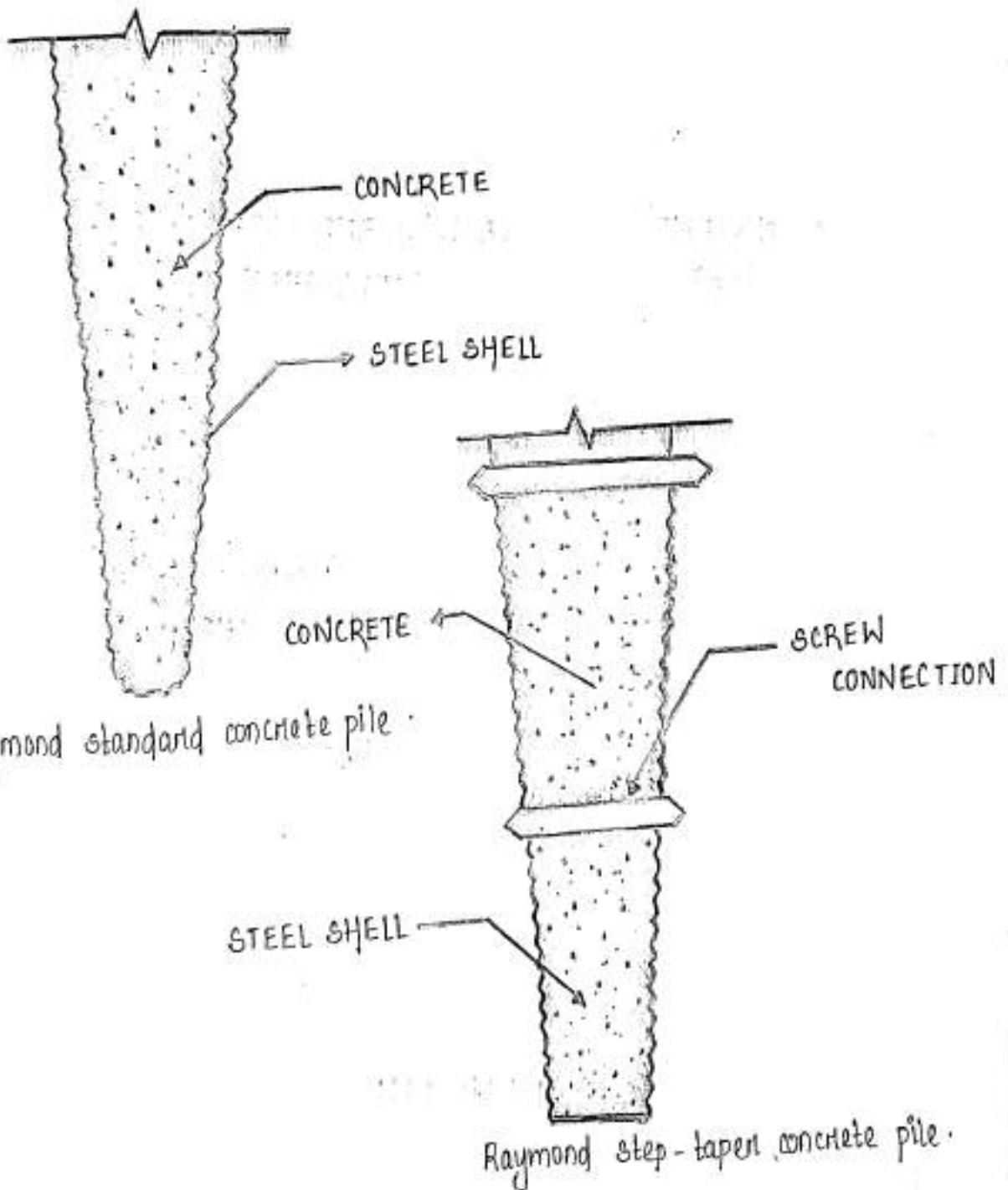

Raymond standard concrete pile.

Raymond step-taper concrete pile.

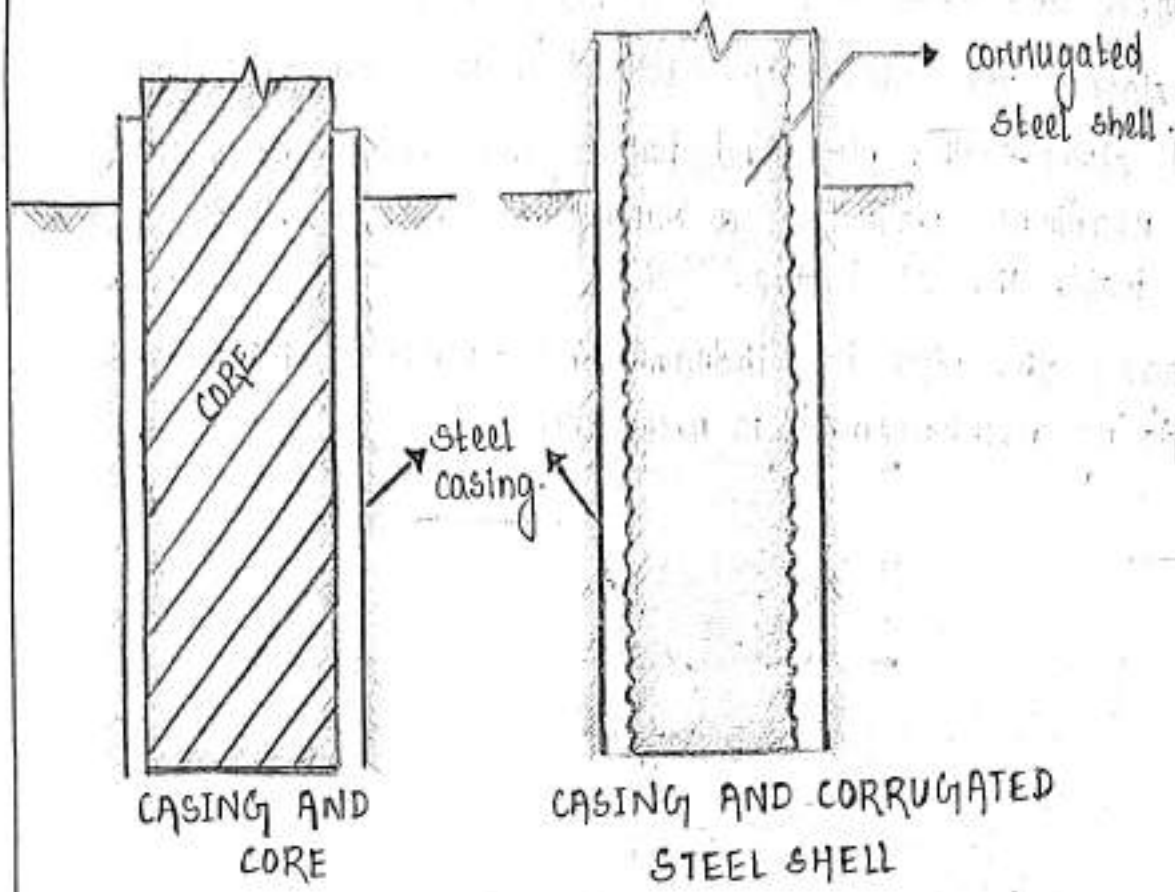

CASING AND CORE

CASING AND CORRUGATED STEEL SHELL

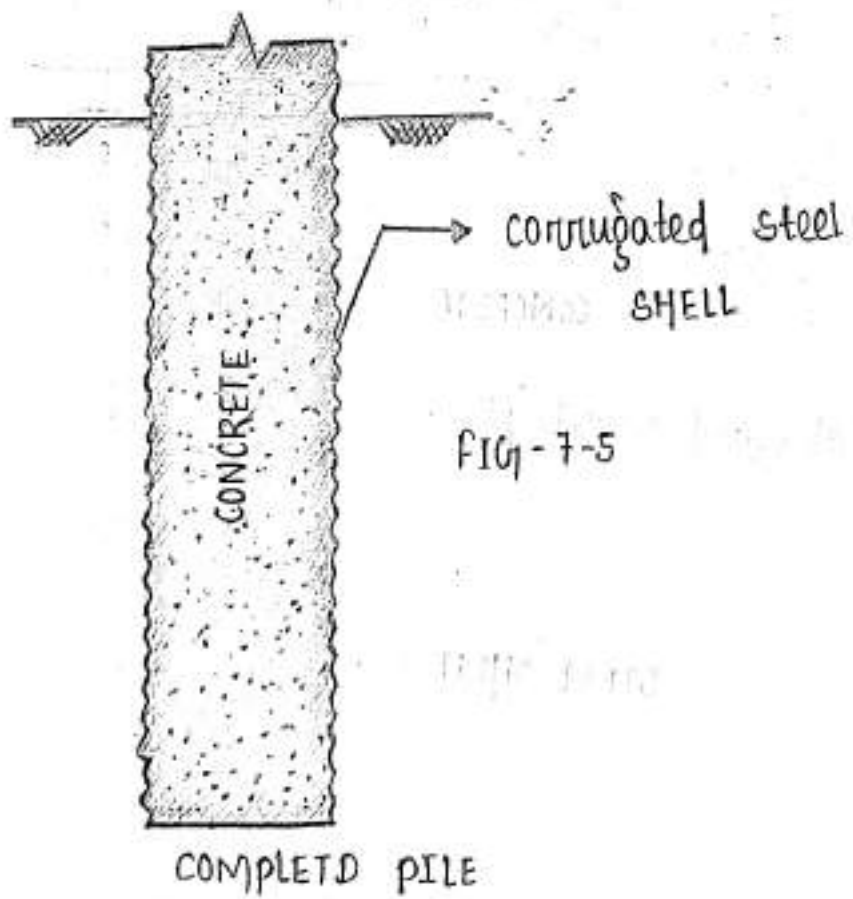

COMPLETED PILE

FIG-7-5



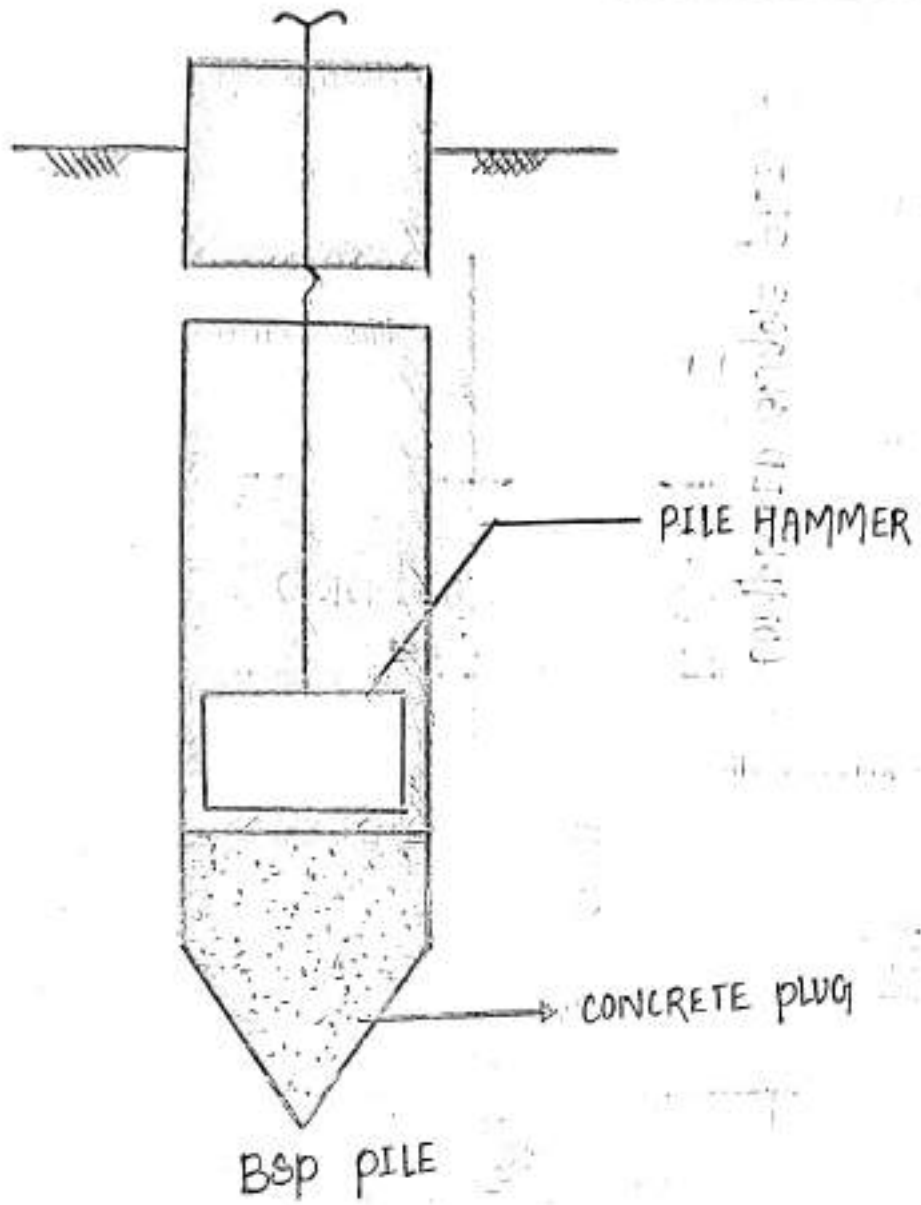

FIRST STAGE SWAGE PILE

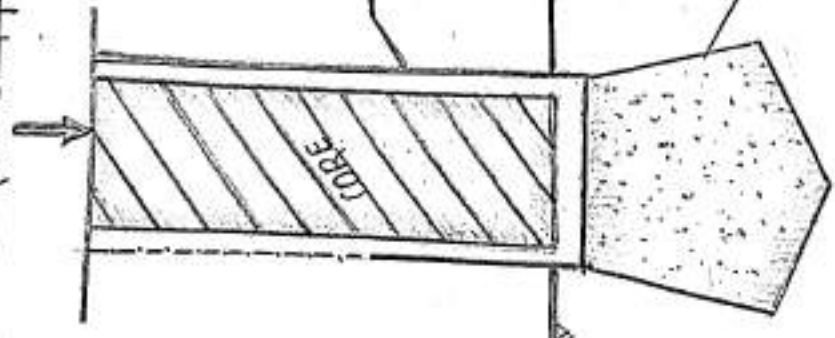

first stage swage pile.

SECOND STAGE SWAGE PILE

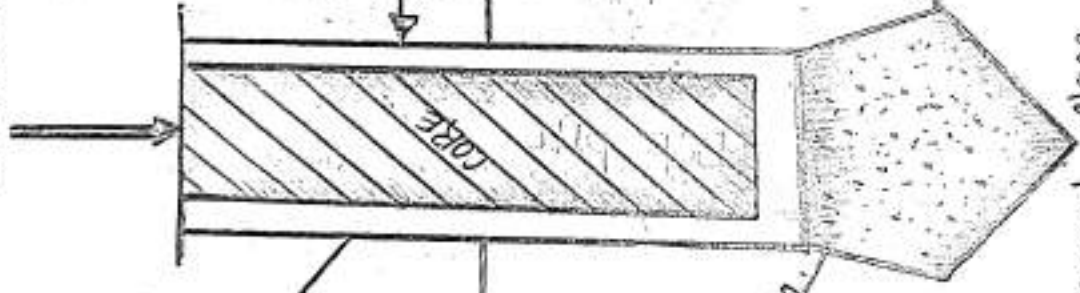

second stage swage pile.

COMPLETED SWAGE PILE



Completed swage pile.

SHELL

shell

concrete plug

concrete plug

MM

MM

FIRST STAGE BUTTON - BOTTOM PILE .

PILE .

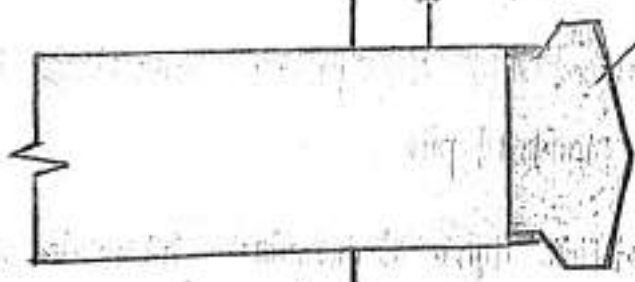

First stage Button-bottom pile .

SECOND STAGE BUTTON - BOTTOM PILE

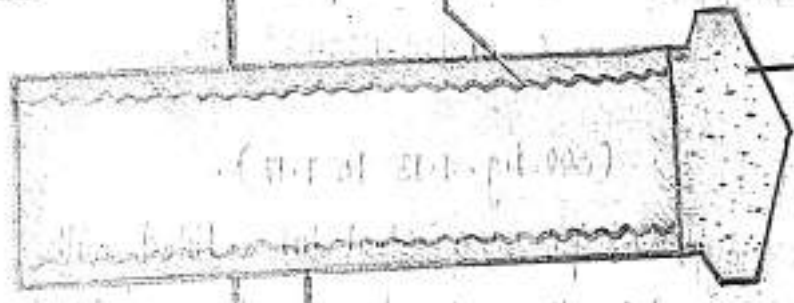

Second stage Button-bottom pile .

COMPLETED BUTTON - BOTTOM PILE .

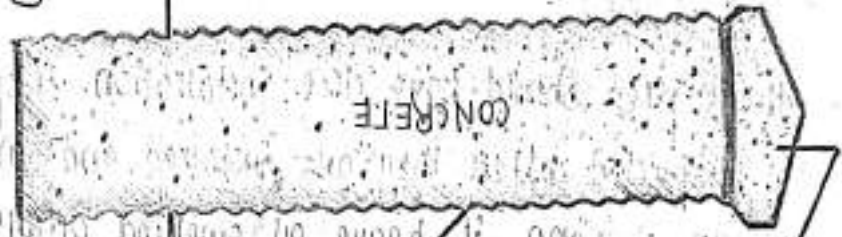

Completed Button-bottom Pile .

## Construction Technology

116

### uncased cast in-situ concrete piles

1. These piles are cheap as no casing is used in the ground and great skill is required for achieving the result.
2. These piles are likely to be damaged from subsoil pressure, and ground movement during pile driving and also obstruction in the ground.
3. These piles should have close installation inspection as they cannot be inspected after they are installed and also they can't be readily redriven if heave or swelling occurs.

### Example of these piles

1. simplex piles.
2. franki piles.
3. vibro piles.
4. pedestal piles.
5. pressure piles.
6. under-reamed piles.

### 1. Simplex piles (see fig. 7.13 to 7.17).

1. In this type of piles, a steel tube fitted with cast-iron shoe is driven into the ground up to the required depth.
2. The reinforcement, if necessary, is put up and concrete is poured into the tube and the tube is slowly withdrawn leaving the shoe into the ground.
3. The concrete is not tamped and the pile is completed. This pile is known as simplex standard pile.
4. If tamping of concrete is done at regular intervals as the tube is withdrawn, it is known as the simplex tamped pile.

5. In case of simplex alligator jaw pile, the cast-iron shoe is provided by a alligator jaw point.

6. In this type of pile, the shoe does not remain in the ground.

2. Franki piles (Fig 7.18 to Fig 7.41)

1. In this type piles, a plug of dry concrete is formed.

2. The plug is rammed by a hammer and the plug the tube into the ground.

3. The required depth is reached, the tube is kept in position by cables.

4. The quantity of concrete is then laid and rammed with such a pressure that the concrete plug is separated out from the tub.

5. Then successive layers of concrete are then laid and as concrete is being rammed, the tube is partly withdrawn.

6. Then reinforcement, if necessary, is put up before withdrawal of tube commences.

7. The pile has corrugated surfaces and possesses frictional resistance.

3. Vibro piles (Fig 7.22 to Fig 7.24).

1. In this type of piles, a steel tube with a cast-iron shoe is driven upto required depth.

2. The tube is connected to the hammer by extracting links.

3. The tube is then filled with concrete and then extracted by downward tamping.

4. It has corrugations in the tube and reinforcement if necessary, is input up before withdrawal of tube.

5. For increasing the area of pile, vibro enlarged piles are used.

6. In case of vibrated enlarged piles, a bigger shoe is provided to increase of area of pile concrete block at the base.
7. The tube is driven with the cast-iron shoe up to the required depth.
8. The concrete is deposited in the tube upto the ground level and no reinforcement is put up in the concrete.
9. The tube is withdrawn and then, it is redriven with a new shoe on the newly placed concrete.
10. The pile is then finished by placing reinforcement pouring concrete and withdrawing the tube.
11. The cross sectional area have is doubled and it increases the bearing power of soil.

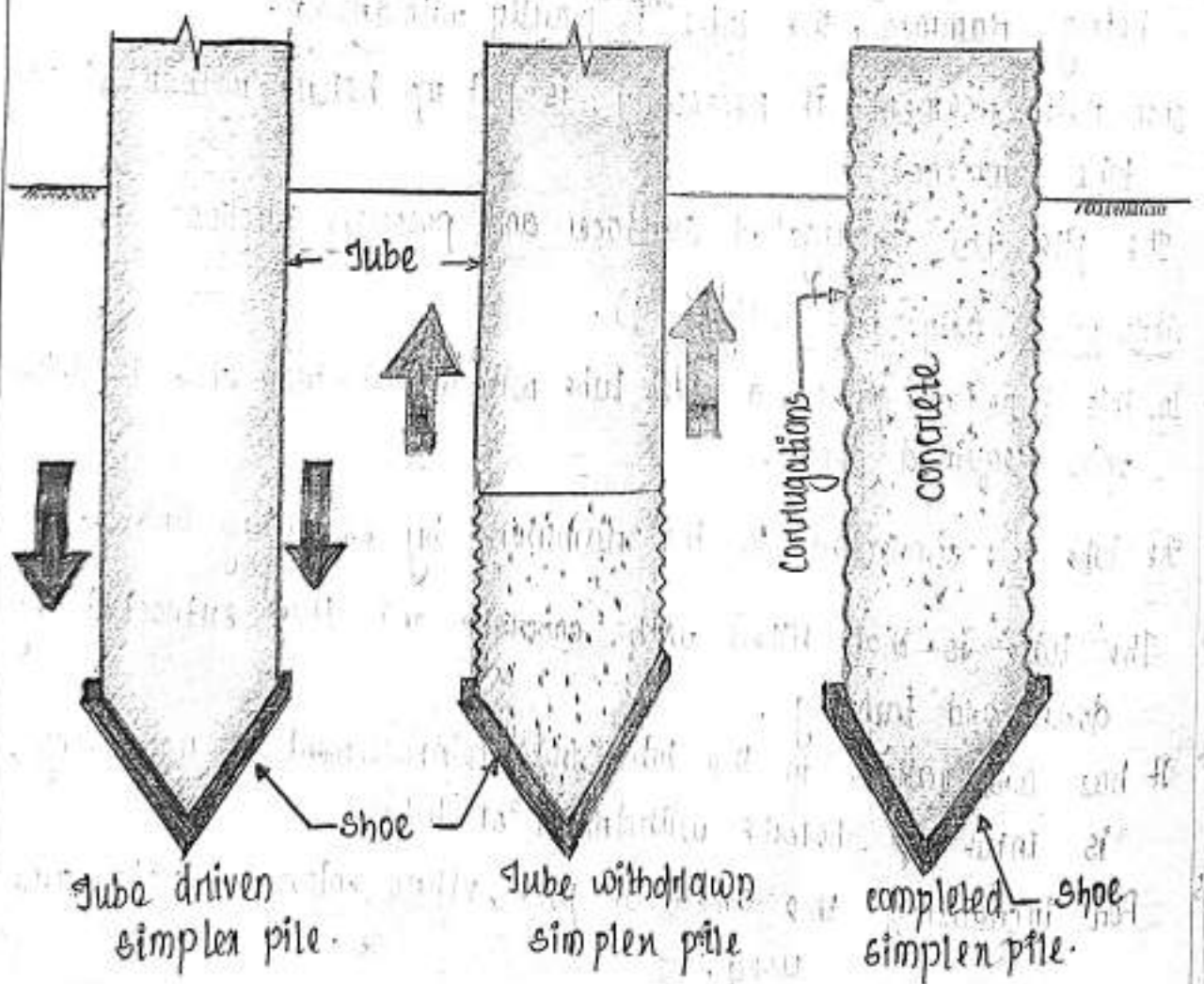

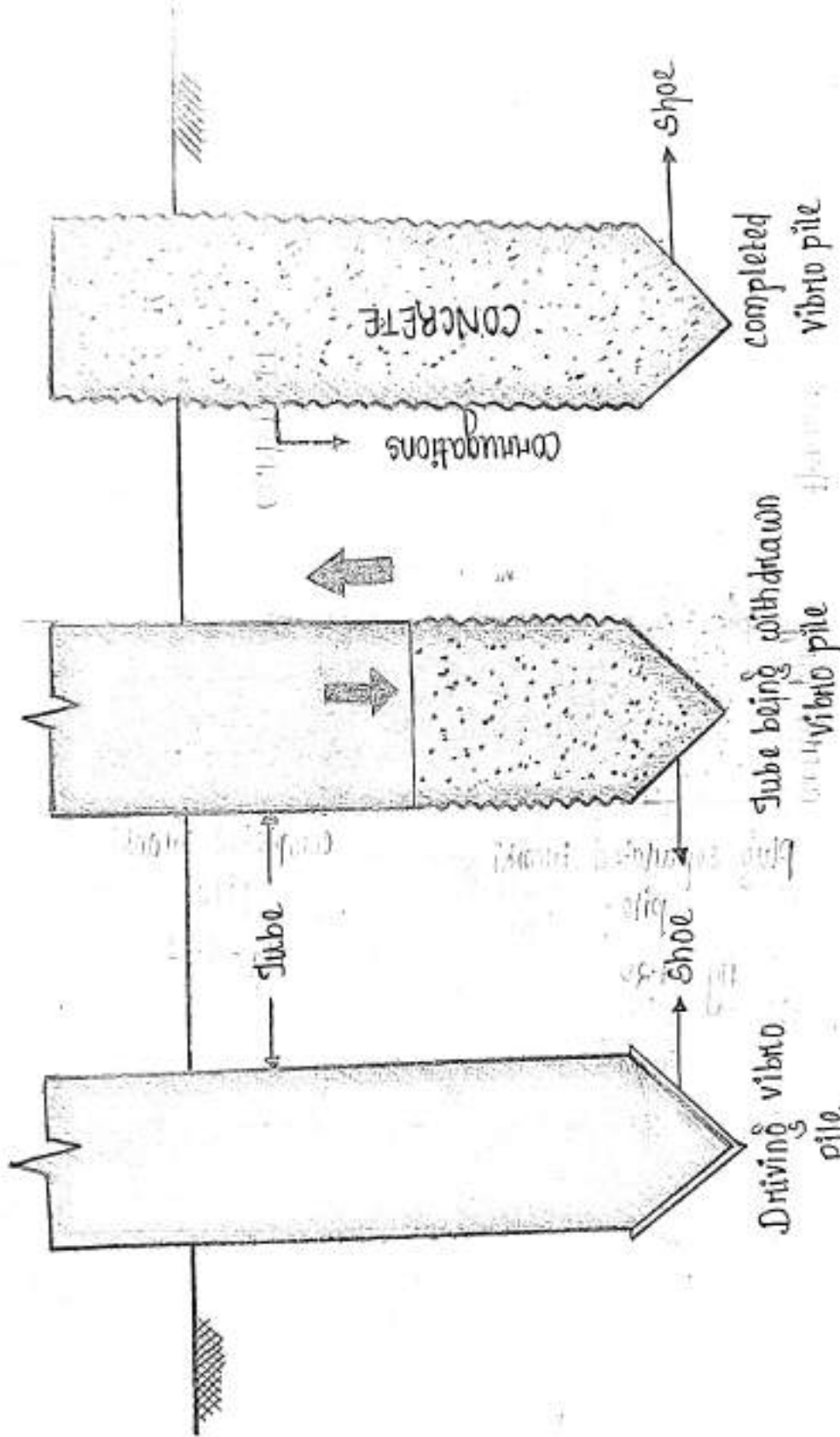
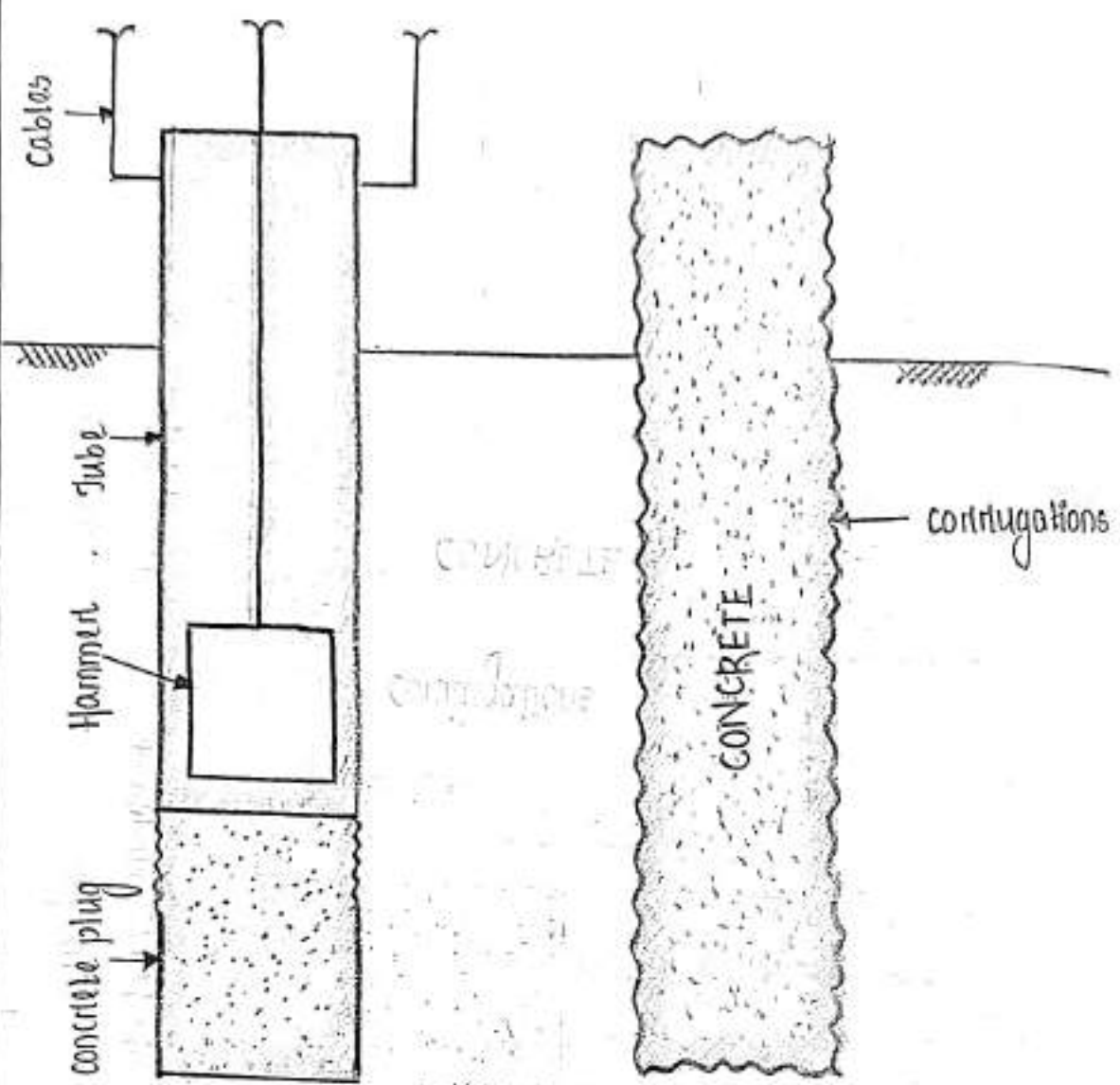

Fig 7-24

Fig 7-23

Fig 7-22



Plug separated Franki pile.

Fig - 7.20

Completed Franki pile.

Fig - 7.21



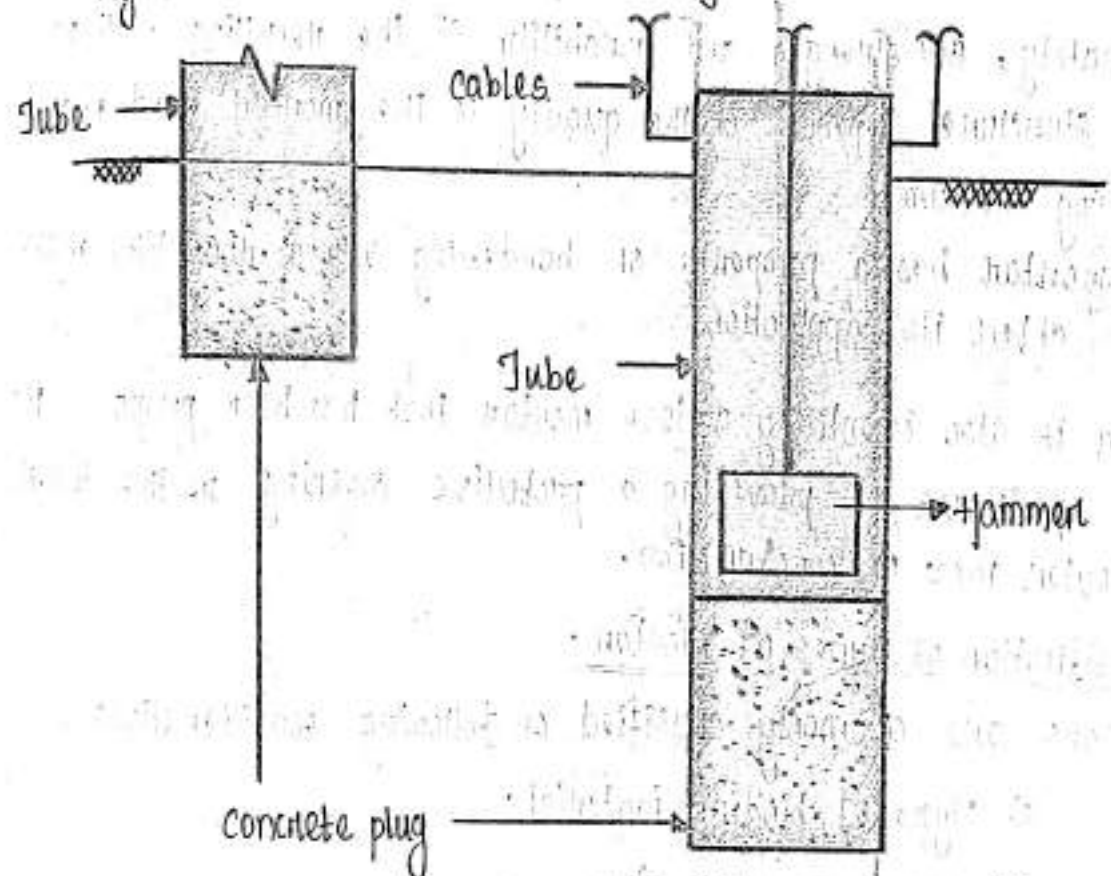
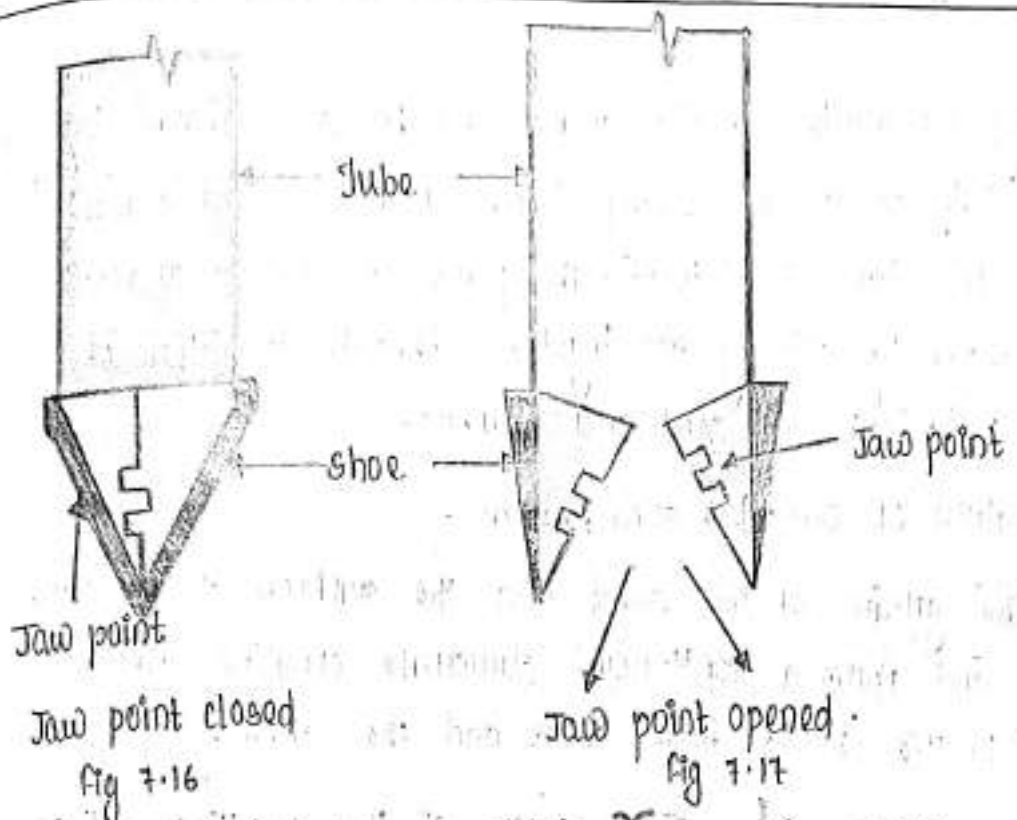

Forming of concrete plug  
Franki pile  
Fig - 7.18

Driving  
Franki pile.  
Fig - 7.19

## Mortar.

1. In building construction should stones and bricks are bound together with the help of an intervening layer of a paste of cementing material like lime or cement. The paste is known as mortar and is made by mixing together definite quantities of cementing materials and sand and water.
2. It is a matrix of cement, sand, water.
3. It binds the grains of the sand and the surfaces of the stone or brick and form a continuous structure offering strong reaction to the loads from above and the sides.
4. The safety, ~~and~~ strength and durability of the resulting wall or any structure depends on the quality of the mortar used as a binding medium.
5. The mortar has a property of hardening into a rock like mass soon after its application.
6. Plaster is also essentially a lean mortar that has been prepared for the purpose of providing a protective covering on the inner or outer faces of construction.

## Classification of Types of Mortar.

Mortars are commonly classified on following considerations.

- a) Type of binding material.
  - b) Nature of application.
  - c) Density of the mortar.
- 
- a) Type of Binding material.
    - i) lime mortar.
    - ii) cement mortar.

ii) surkhi mortar .      iii) Gypsum mortar .      v) Gauged mortar .

i) Lime Mortar .

1. In lime mortar, a fat lime or hydraulic lime is used as the binding materials.

2. Fat lime can't be used in damp and moist condition.

3. Hydraulic lime is suitable for use even in damp situation.

ii) Cement Mortar .

1. It contains portland cement as a binding material and mixing with sand.

2. The most of the quality construction work lies with the cement mortar.

iii) surkhi mortar .

1. It is ordinary type of mortar where sand is partly replaced by surkhi (crushed burnt bricks) as a filling material in lime mortars.

2. surkhi can't be used in reactive cement.

3. surkhi mortars are quite commonly used in foundation works.

iv) Gypsum mortar .

1. It is not used in tough construction.

2. It is generally used for application as plasters (covering coats).

v) Gauged mortar .

1. It is made by adding portland cement and lime together in properly determined portions as binding material.

2. It is dense, stronger and durable than original lime mortar.

3. It is inferior to cement mortar.

Nature of Application .

i) Brick laying or masonry mortars : It is generally used as building medium between the brick masonry in the construction of foundation and the wall of building.

(i) Depending upon the nature construction we may use lime mortar, lime surkhi mortar and cement mortars of various composition.

(ii) For brick laying we are using masonry mortar.

Density of Mortar - (Two types) -

(i) Heavy Mortar - (i) It is used for load bearing construction.

(ii) Bulk density is greater than  $1500 \text{ kg per cm}^3$

(iii) For special work, special heavy mortar having bulk density  $2200 \text{ kg/cm}^3$  is used

Example - n-Hay room.

(iv) High density rock crushed to sand grain size is used.

(ii) Light weight Mortar - (i) Here the bulk density is below  $1500 \text{ kg/cm}^3$ .

(ii) sand contains quartz and pumice stone crushed to sand grain size is used and a last furnace slag and cinder is used on place of sand.

(iii) Bulk density between  $600 \text{ kg/cm}^3$  to  $1000 \text{ kg/cm}^3$  is used for sound proof ceiling and walls.

Uncased cast-in-situ concrete piles.

(i) pedestal piles.

(i) In the first stage of this pile a casing in the form of tube with a core is driven up to the required depth.

(ii) The bottom is made even.

(iii) In the second stage, the core is withdrawn and a layer of concrete is deposited in the casing.

(iv) In the third stage, the core is placed again in the tube.

(v) The pressure is applied on the concrete through the core and at the same time the casing is withdrawn.

(vi) Doing this process a concrete pedestal is formed.

(vii) The process is repeated till casing is completely removed.

### Pressure piles.

In the first stage of this pile, a hole is bored into the ground by means of an auger and as the boring proceeds, the hole is lined by a steel tube.

When the tube reaches the required depth, the boring tool is withdrawn. The reinforcement, if any, is then put up in the tube.

In the second stage, a layer of concrete is laid and pressure cap is provided at the top of the tube.

The compressed air is then admitted through the air pipe and winch is applied to raise the tube.

The tube is lifted slightly and at the same time, the concrete is forced into the surrounding ground by compressed air.

The process is repeated till the pile is completed.

One care should be taken to see that some portions of concrete remains at the bottom tube when lifting of tube is stopped to receive a new layer of concrete. Otherwise the water or loose soil may gain access to the inside of the tube and there will be loss of compressed air.

It creates consolidation and vibration of concrete for expulsion air from concrete.

Under-reamed piles.

### Under-reamed piles.

It is developed by C.B.R.T, Roorkee up, for serving as the foundations for black cotton soil and other types of soil having poor bearing capacity.

An under-reamed pile is a bored cast-in-situ concrete pile having one or more bulbs or under-reams in its reaming tool of lower portion.

3. The bulbs on under-reams are formed by unreaming tool.
  4. The diameter of an under reamed pile is about from 400 mm to 500 mm and that of bulb varies from 1 to 2 times the diameter of pile.
  5. The length of the under-reamed pile is about 2m to 8m and bucket length minimum is 300 mm is provided.
  6. The spacing of piles may vary from 2m to 4m and the safe load for an under reamed pile varies from 200kN to 400 kN.
  7. This pile can also used in sandy soils with high water table.
  8. The load bearing capacity of the under reamed piles can be increased by adopting piles of large diameter or by extending the length of piles or by making more bulbs at the base.
  9. A single under reamed pile has only one bulb at the bottom.
  10. When the no. of bulbs at the base is two or more it is known as a multi under reamed pile.
  11. The vertical spacing between two bulbs varies from 1.25 to 1.50 times the diameter of bulb.
  12. Under reamed pile is selected by consideration of pile length, stem diameter, bulb diameter and no. of bulbs and site conditions.
  13. In black cotton soil, under reamed pile increase load bearing capacity and anchorage against uplift also for reclaimed soil, pile provides large bearing area.
  14. For heavier load multi under reamed piles can be adopted.
- The under-reamed piles is used under the following circumstances.
- a) taking the foundation through weaker strata into firm ground when the depth of such strata is shallow.
  - b) providing anchorage against up lift forces.
  - c) providing foundation through filled up soil deposits or reclaimed soil.

Under-reamed piles.

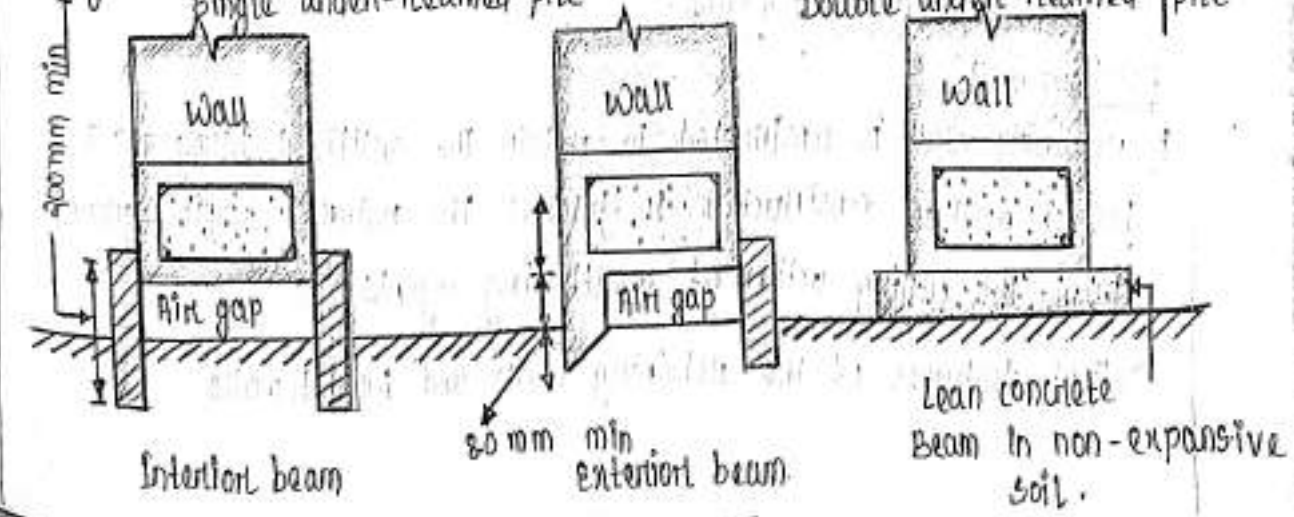
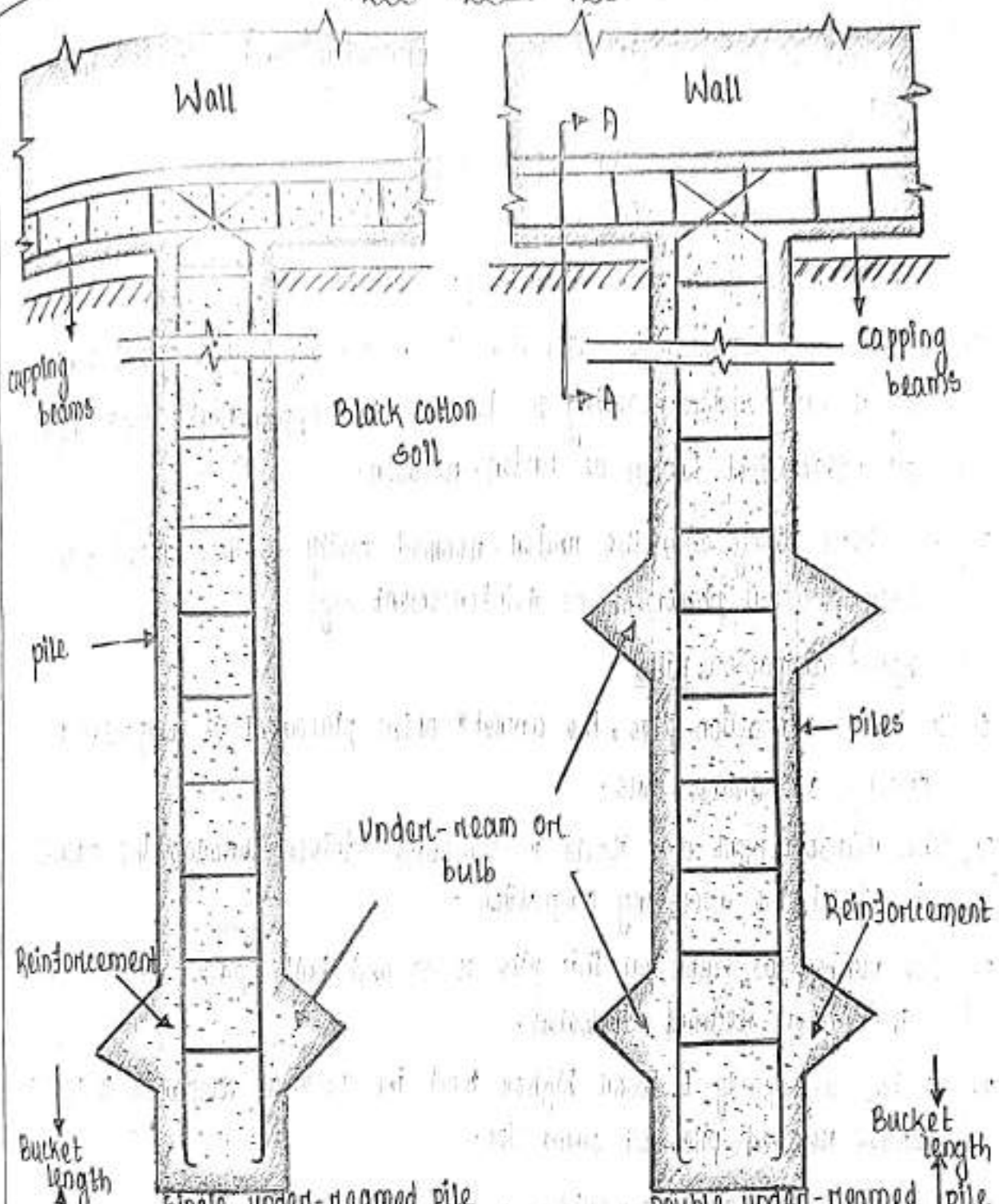

## Construction Technology

### Types of under-reamed piles.

The under-reamed piles adopted currently can be divided in two categories:-

- i) Bored and cast-in-situ concrete piles.
- ii) Bored compaction piles.

### Bored and cast-in-situ concrete piles.

1. A bore of approximate diameter is made by using spiral earth auger and under-reaming is done at the appropriate depth by a collapsible tool known as under-reamer.
2. The bore along with the under-reamed cavity is then filled with concrete after placement of reinforcement cage.

### Bored compaction piles

1. In bored compaction piles, the concrete after placement is compacted by driving a suitable core.
2. The reinforcement cage itself is sometimes driven through the concrete to effect the necessary compaction.
3. The number of bulb for this pile is 03 and bulb spacing is 1.5 times the under-reamed diameter.
4. It has a capacity to bear higher load i.e 50% as compared to normal under-reamed piles of same size.

### Walls and masonry works.

#### Retaining wall

A retaining wall is constructed to retain the artificial filling and a breast wall is constructed to protect the natural sloping ground from the cutting action of weathering agents.

Salient features of the retaining walls and breast walls.



- i) The earth pressure increases as the depth of retaining wall or breast wall increases from top so the section is gradually increased from top to bottom.
- ii) In case of retaining walls, the back is generally stepped and the face may be vertical, inclined or curved.
- iii) Retaining walls of rectangular cross section are economical upto a height of 3m.
- iv) Breast walls are constructed similar to the retaining walls and sometimes, they are provided with batter on face and back.
- v) The usual batter provided for face and back are 1:2 and 1:3.
- vi) When the retaining wall is surcharged i.e. when the height of earth to be retained is more than the height of the retaining wall, the design should be carefully done.
- vii) The retaining walls are sometimes provided with inclined supports on the earth side is known as counterfort and they are placed at a centre to centre distance of about 3m to 4m.
- viii) The provision of counterforts reduces the quantity of brickwork, makes the face vertical and increases the strength of retaining wall.
- ix) The weep holes in sufficient number should be provided in the section of retaining wall and a breast wall to drain off the water from earth side.
- x) If weep holes are not provided the wall will act as a dam.
- xi) Filters are provided in the weep holes to retain the sand particles and one weep hole cover  $3m^2$  area of the surface.
- xii) The design of retaining walls and breast wall is same but the function is different.

Stability of Retaining wall and Breast wall.

1. Stability of a retaining wall and a breast wall should be checked against sliding and over turning.
2. No tension is developed at any section.
3. The intensity of compressive stress at any section is within the permissible limits.
4. The thickness of the wall before filling may be kept between  $0.33 h$  to  $0.40 h$  upto a height  $h$  and also it depends upon filled material.
5. For long retaining walls, it is desirable to provide the expansion joints at a distance of  $6m$  to  $9m$ .

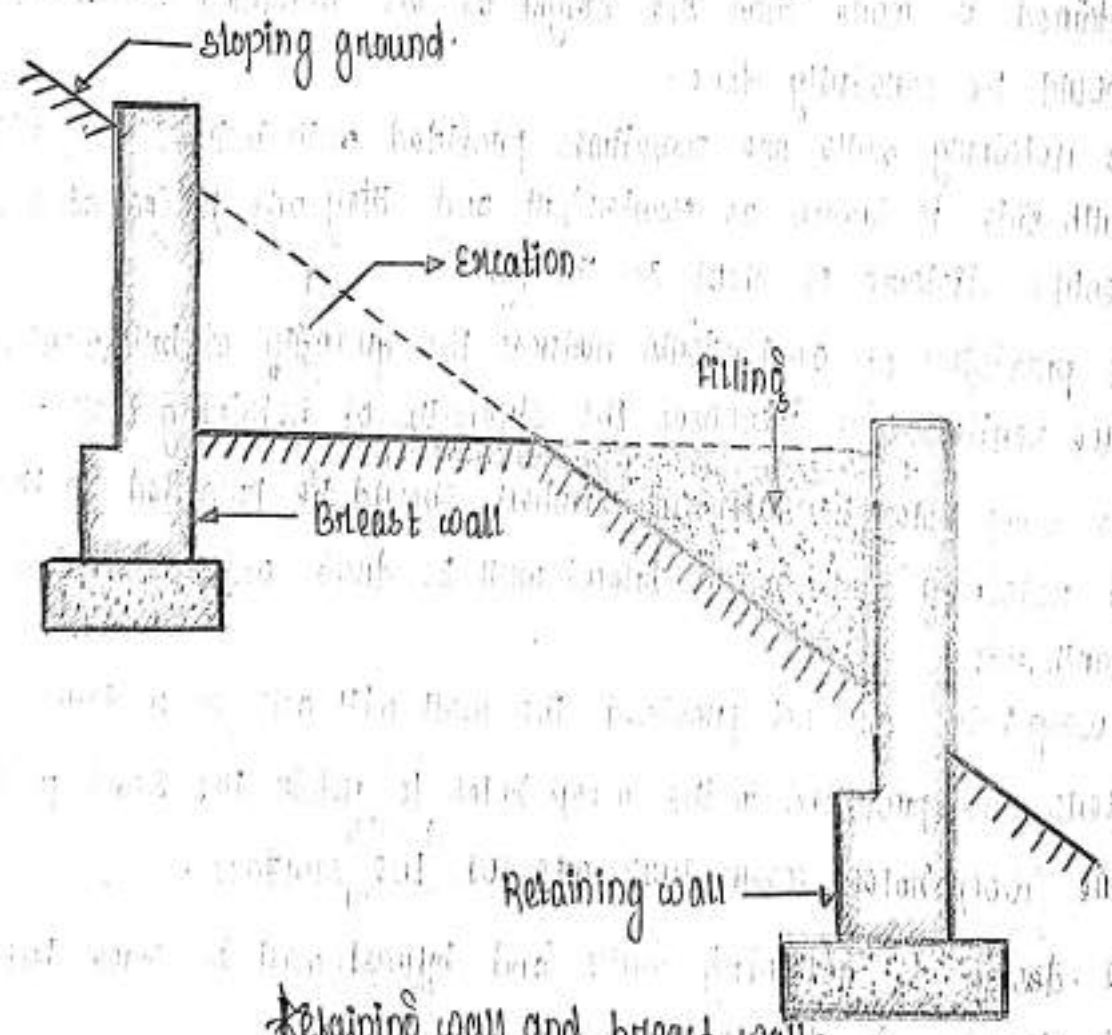

Retaining wall and breast wall.

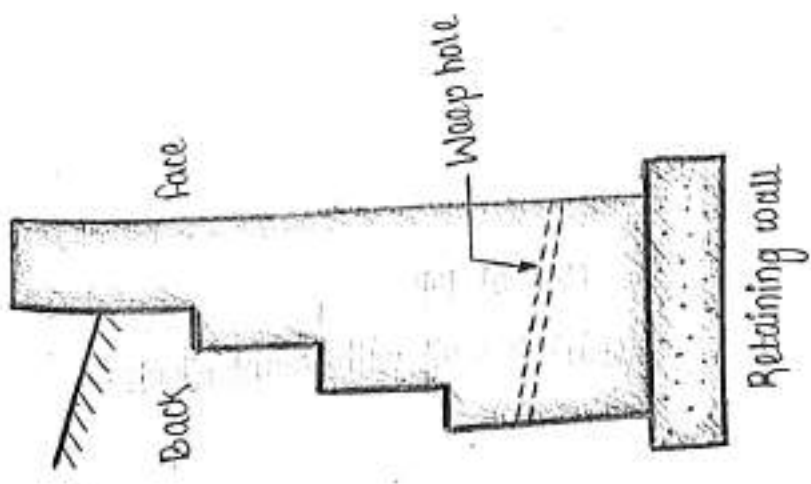
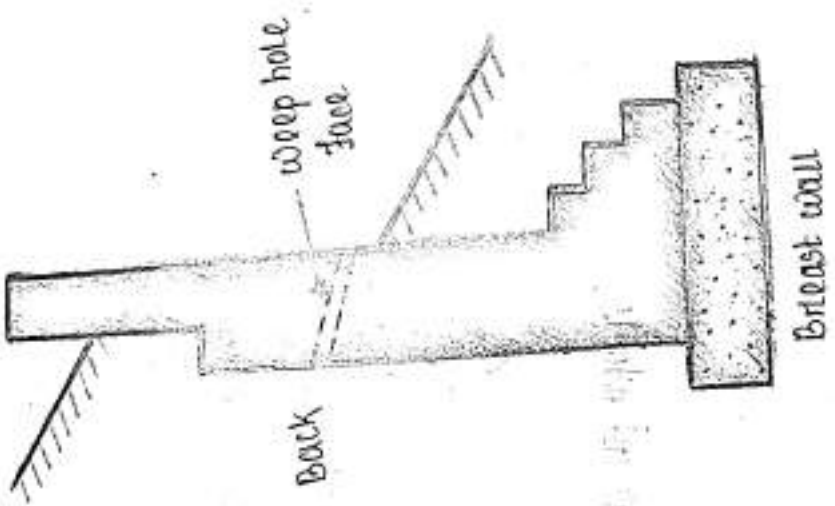
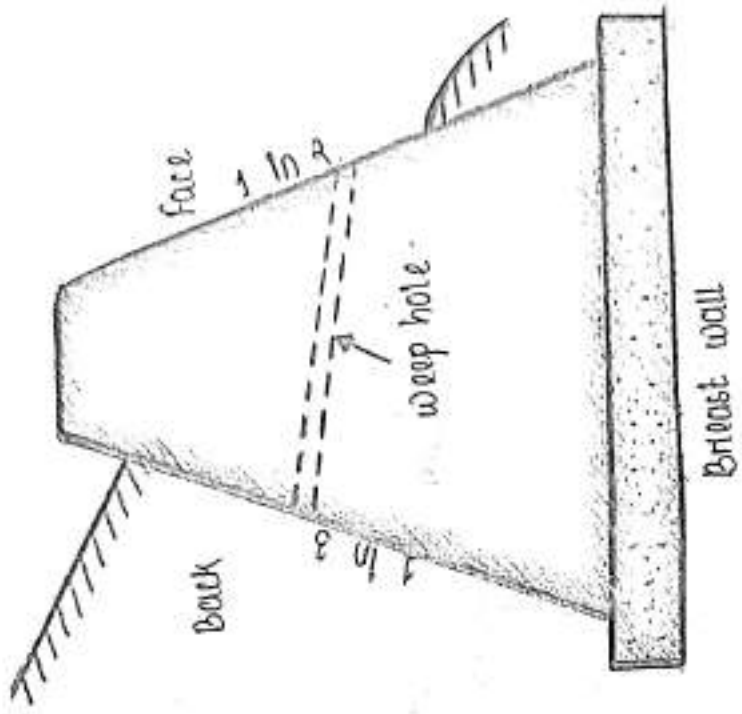

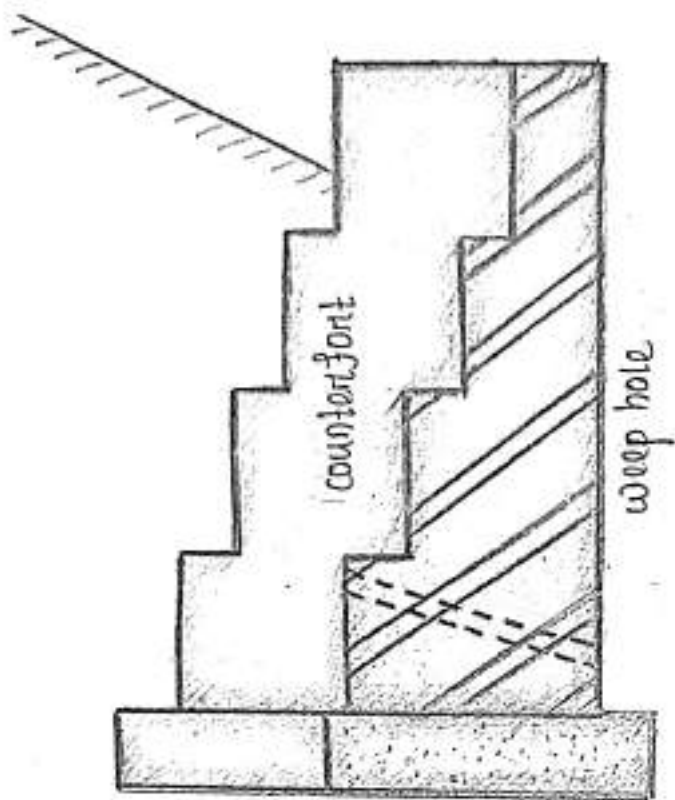

Section on AB

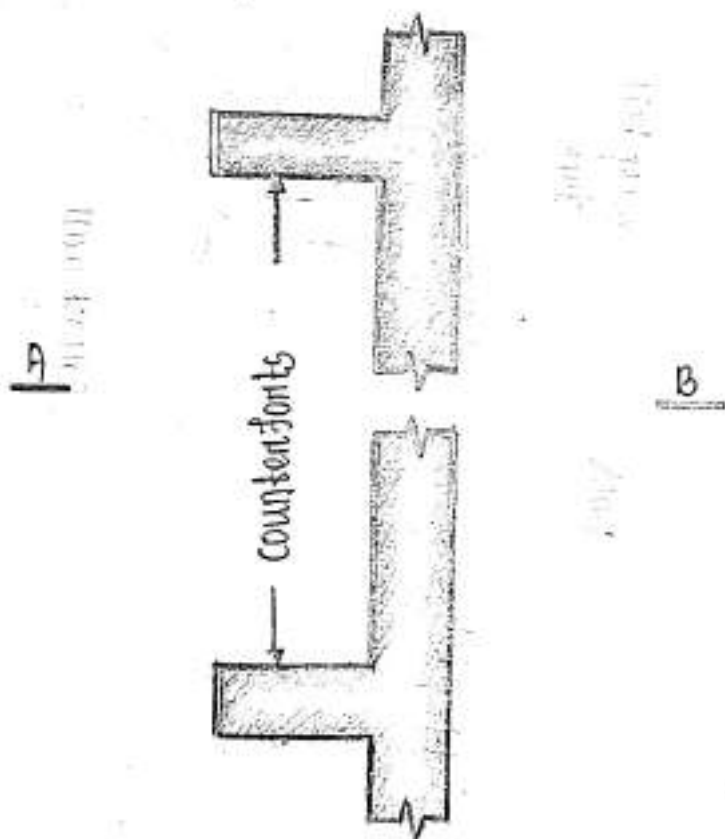

Plan at top

Retaining wall with counterforts.

## Construction Technology

### Equipment Required for under-reamed pile.

1. The equipment has been developed at the C.B.R.I Roorkee.
2. It is simple and light in weight.
3. The basic tools are a spiral auger for boring, an under-reamed for making bulb and a boring guide to keep the hole vertical or at the desired inclination.
4. For special requirement other accessories may required.
5. For deep and large diameter under-reamed piles, tripod hoist with which is required.
6. For large construction project a mechanised pile boring has also been developed.

### (Under reamed pile foundation for building).

1. The piles are connected by a rigid capping beam which is suitably reinforced and other which the wall is constructed.
2. An air gap of about 80 mm to 100 mm height is kept between the capping beams and the ground so that soil does not heave against the beam and the full load will be taken by the pile.
3. For interior beams, the brick on edge or 50 mm thick concrete slab is provided on both sides to cover the air gap.
4. In non-expansive soils proportion of 1:3:6 or 1:4:8 of 80 mm to 100 mm thickness is provided between the ground and the bottom of the beam.

### Load bearing wall.

1. A load bearing wall is one which rests on the foundation taken deep into the sub soil.
2. It takes super-imposed load i.e. the load transmitted from slabs and beams and it transmits the load of the superstructure on the subsoil on which it rests.

3. The entire wall should be taken deep into the ground where the enlarged footings provide enough stability for it.
4. The stress transmitted is considerably reduced because of increase in width of footings.

### Partition wall

1. A partition wall is an internal screen wall which rests above the floor level to create a room or enclosure.
2. It is not anchored deep into the soil and may not take any load of superstructure.
3. According to structural system, there are three types of buildings:
  1. load bearing structure.
  2. framed structure.
  3. composite structure.

### Load bearing structure

1. The system of building consists of slabs, beams and load bearing walls is known as a load bearing structure.
2. The residential buildings are small in size and are up to three storey are generally constructed as load bearing structures.
3. In load bearing structures, walls of the upper floors have less thickness than the walls of lower floors, so compared to upper floors, the carpet area at lower floors will be less.

### Framed structure

1. It is a structure consists of slab resting on beams which are supported by a network of column.
2. The live load from the slab is transferred to the cross beams which is transfer it to main beams through rigid joints.

3. All the walls may or may not be a partition wall.

1. Main beams rest over columns and load from the beam is transferred to the soil through columns and their footings.

2. All the walls rest on plinth beams.

3. All multistoried buildings or high-rise building are constructed as framed structure.

4. All the frame are constructed monolithically.

5. It takes a variety of external loads like compressive, tensile, torsion and shear along with moments.

6. R.C.C. is the most suitable material to withstand all these loads.

7. More carpet area is available for all the floors.

8. Composite structure.

1. some of the buildings are constructed with combination of both load bearing as well as framed structure and is called composite structure.

2. In this type of structure external walls are treated as load bearing walls and all intermediate supports are in the form of R.C.C. columns.

3. It is preferred for the building having large spans such as warehouse, workshops, halls, large factory sheds.

Reinforced Brickwork.

When strength is the main criteria in the design of a brick wall, it is desirable and economical to give reinforcement of steel or iron in the body of the brick work is known as reinforced brick work.

Types of partitions.

1. Brick partitions.
2. Clay block partitions.
3. concrete partitions.
4. Glass partitions.
5. Timber partitions.

6. Metal partitions.
7. plaster slab partition.
8. Asbestos cement sheet partitions.
9. wood wool slab partitions.
10. straw board partitions.

### Brick partitions

The half-brick partitions are very common and they may be plain, reinforced or brick nogged.

USE - It is used for prevention of fire and sound.

### Wooden partitions

In this partitions, the wooden framework is properly supported on floor and filled to the side walls. It consists of horizontal and vertical members.

USE - where wood is plenty available.

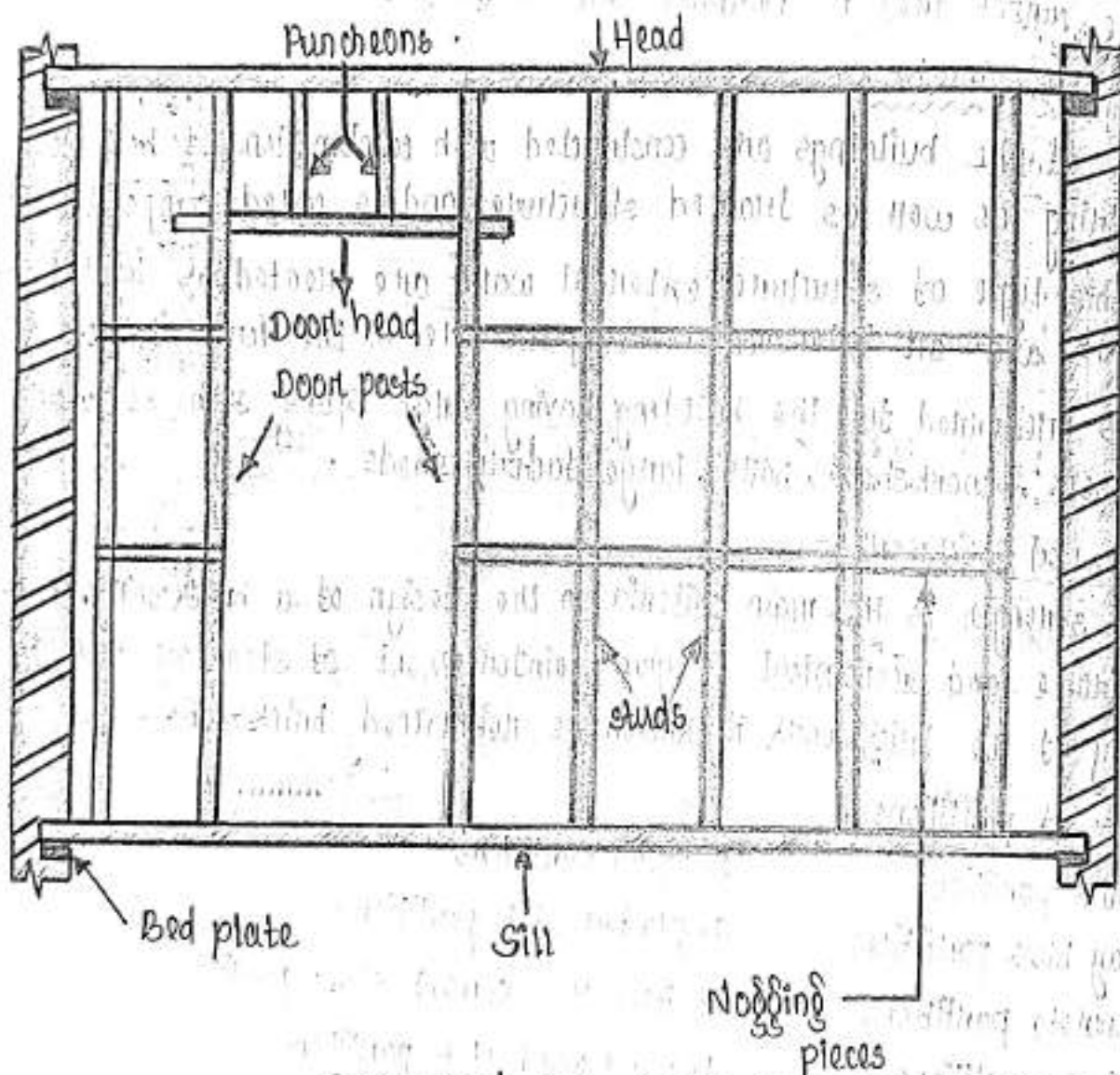

COMMON OR STUD PARTITION



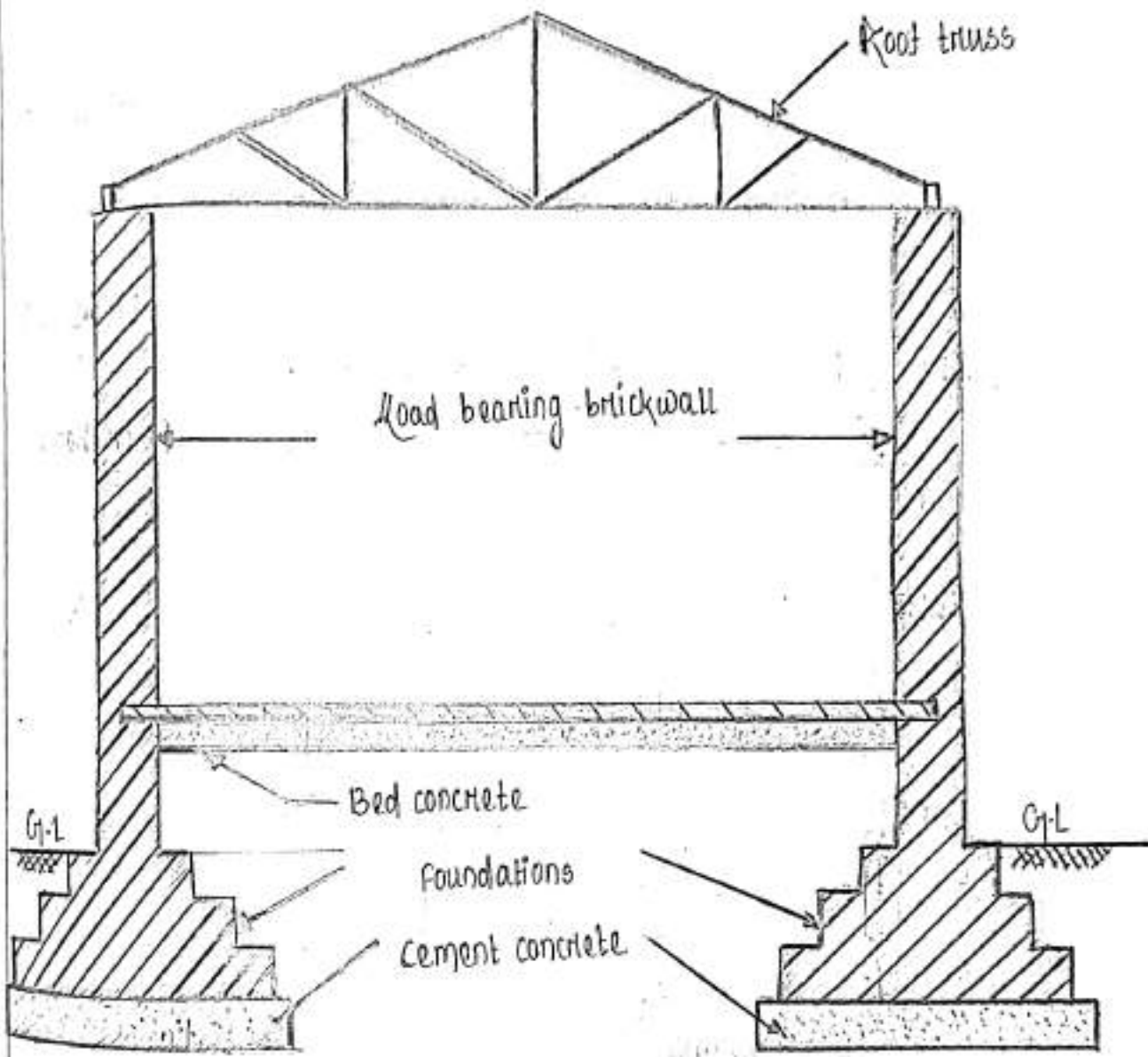

Load bearing structure.

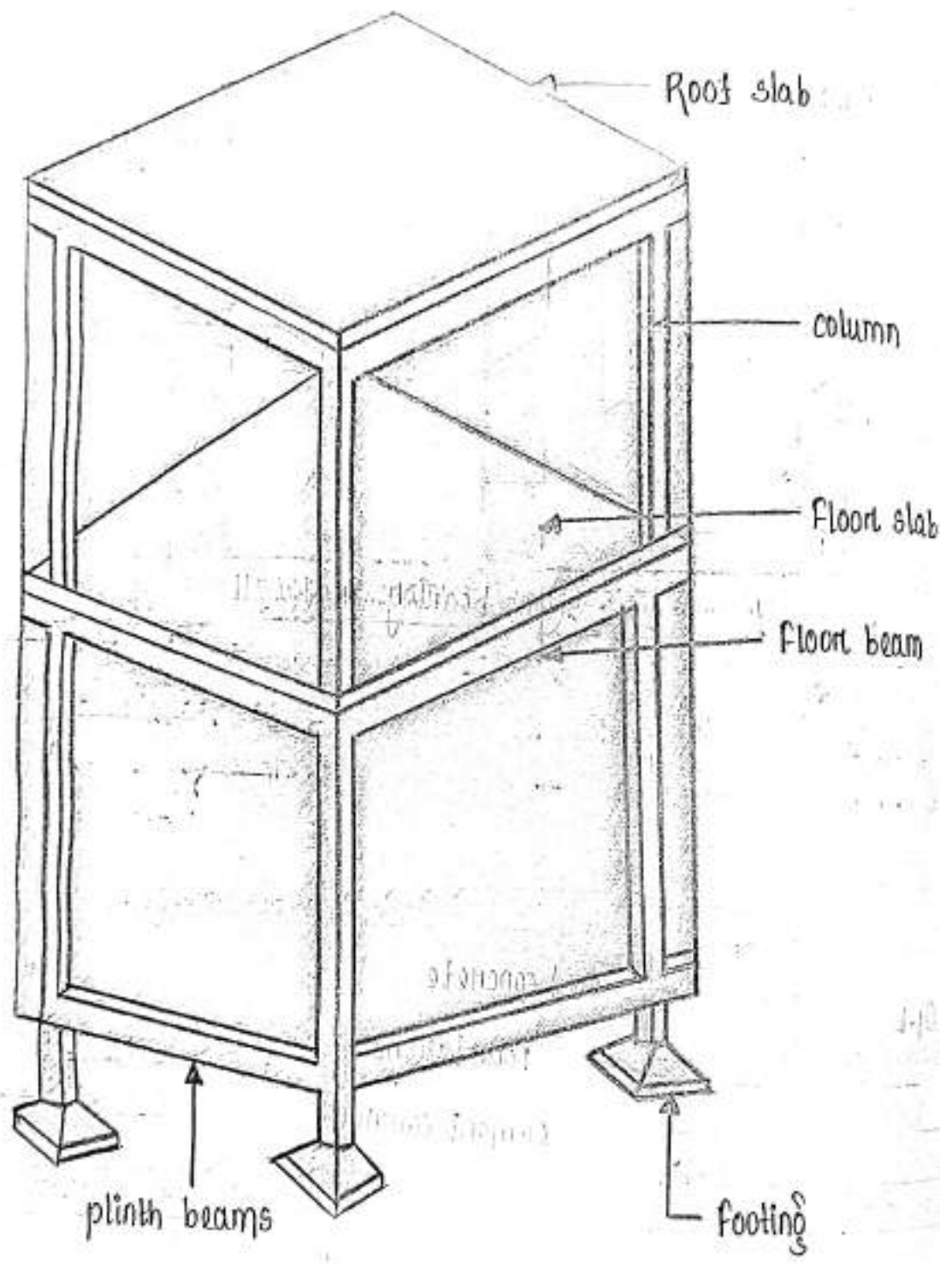

Framed structure.

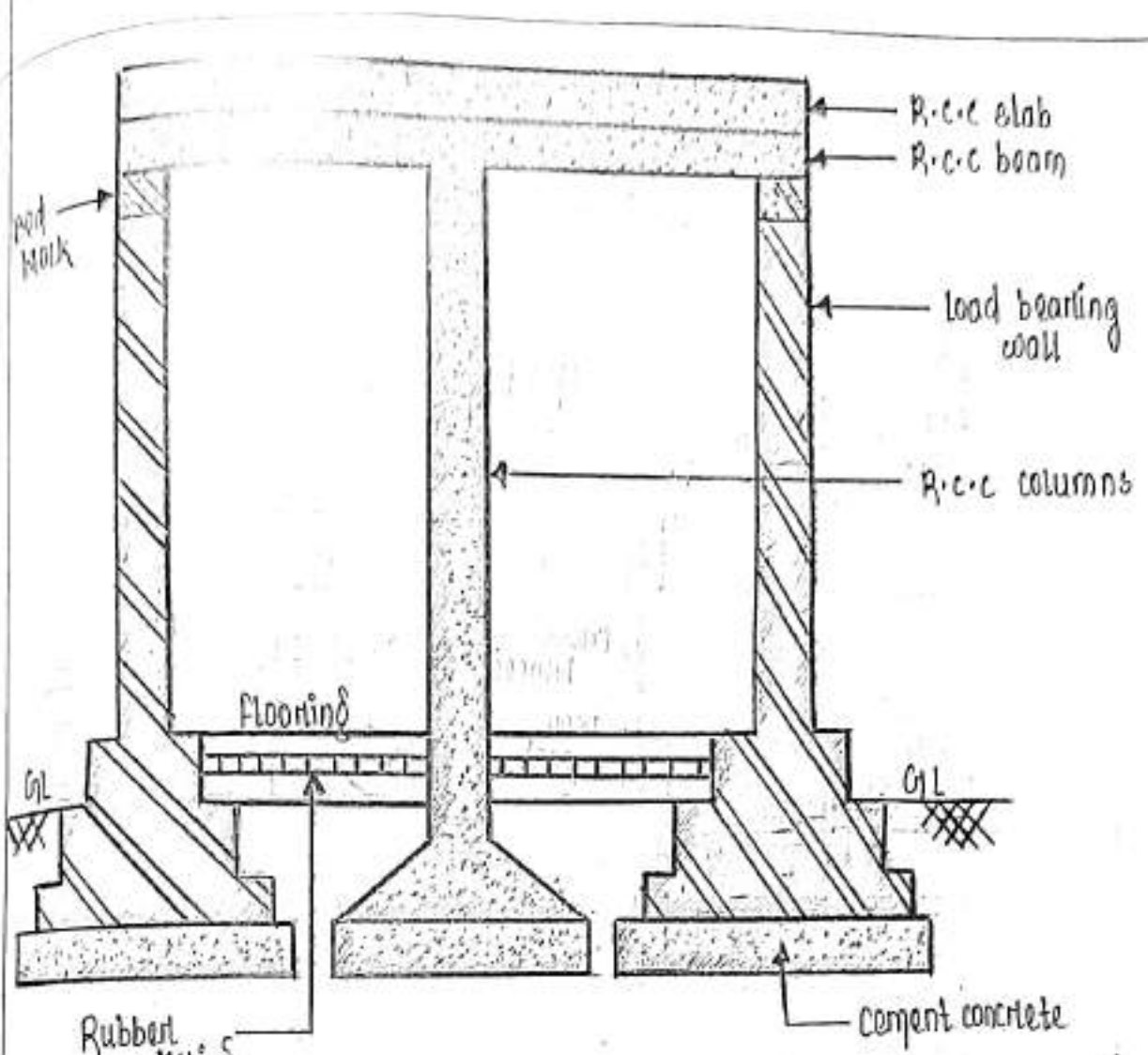

COMPOSITE STRUCTURE.

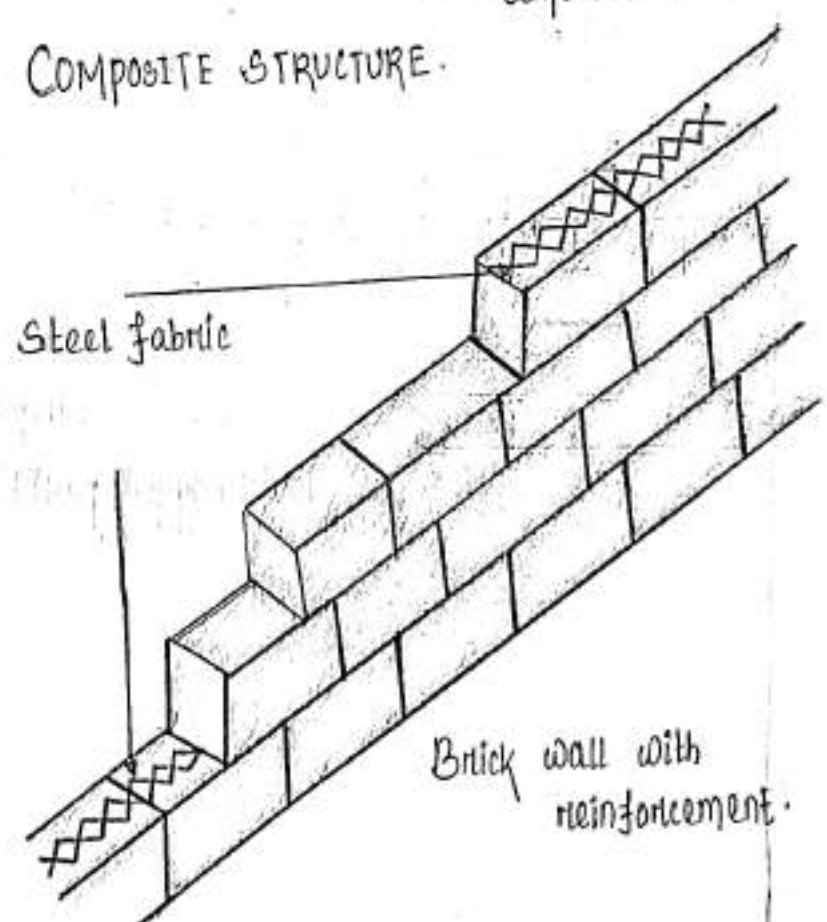

Brick wall with reinforcement.

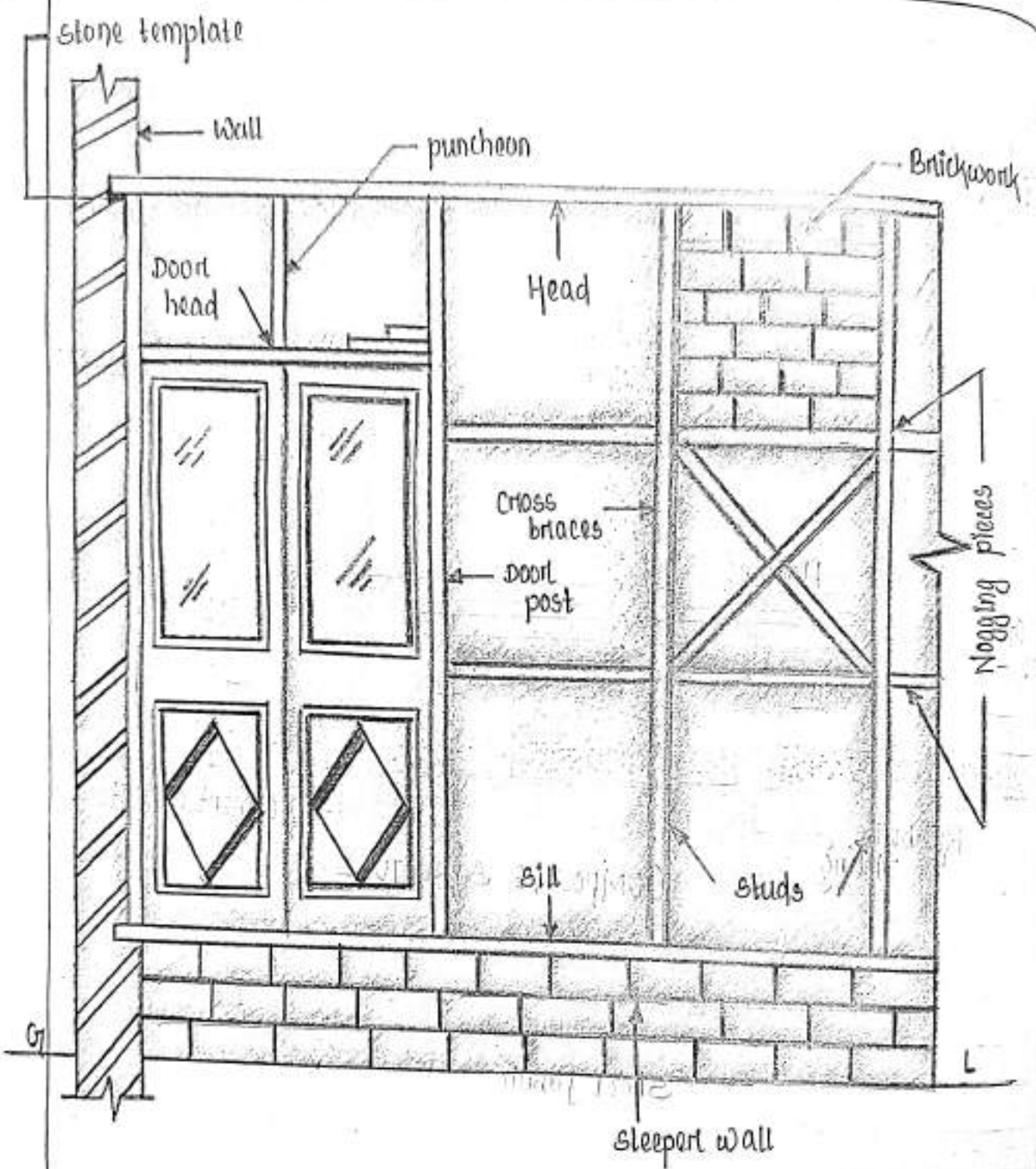

Bricknogged partition.

## Sources of sand and its classification.

### fine and coarse aggregate

fine aggregates - It most of the particle pass through 75 mm sieve and contain only so much coarser material as is permitted for various grading zones.

coarse aggregates - It most of the particle retain on 4.75 mm sieve and contain only so much coarser material as is permitted for various grading zones or specification.

### sources of sand

1. Various sands are commonly used as fine aggregate and obtained from river beds or by crushing the rock.

2. Flyash is also sometimes used as a part of replacement of fine aggregate.

3. The sand obtained from river bed contains particles of varying size and easy to procure.

4. sand should not contain more than 5 percent dirt if it is natural sand and 2 percent in case of crushed sand.

5. sand contains mica reduces strength and durability of concrete.

6. The particle shape of river sand, desert, sea shore and wind blown sand is rounded.

## Bulking of sand (Experiment)

### Bulking factor test

1. Take 500 gm ( $V_1$ ) of dry sand by mass.

2. put it in a mixing pan and add one percent water (s.c).

3. Mix it thoroughly to get uniform colour.

4. fill it in the measuring cylinder and note the volume ( $V_2$ ).

5. The increase in volume is ( $V_2 - V_1$ ) and percentage bulking is  $\frac{(V_2 - V_1)}{V_1} \times 100$

6. Bulking factor -  $\frac{\text{volume of moist sand}}{\text{volume of dry sand}}$

7. Repeat the procedure of experiment using different percentage of water.
8. plot graph of bulking factor vs moisture content, by percentage of dry mass of sand.
9. this is known as bulking curve.

NOTE

Finer sand has higher maximum bulking factor than that of a coarse sand, as large surface area is available with finer sand.

Salt contamination.

1. sand obtained from sea-shore or from a river estuary contains salt.
2. This salt is harmful as it absorbs water from air, causes efflorescence and corrosion of reinforcement.
3. The fine aggregate should wash in fresh water before use.

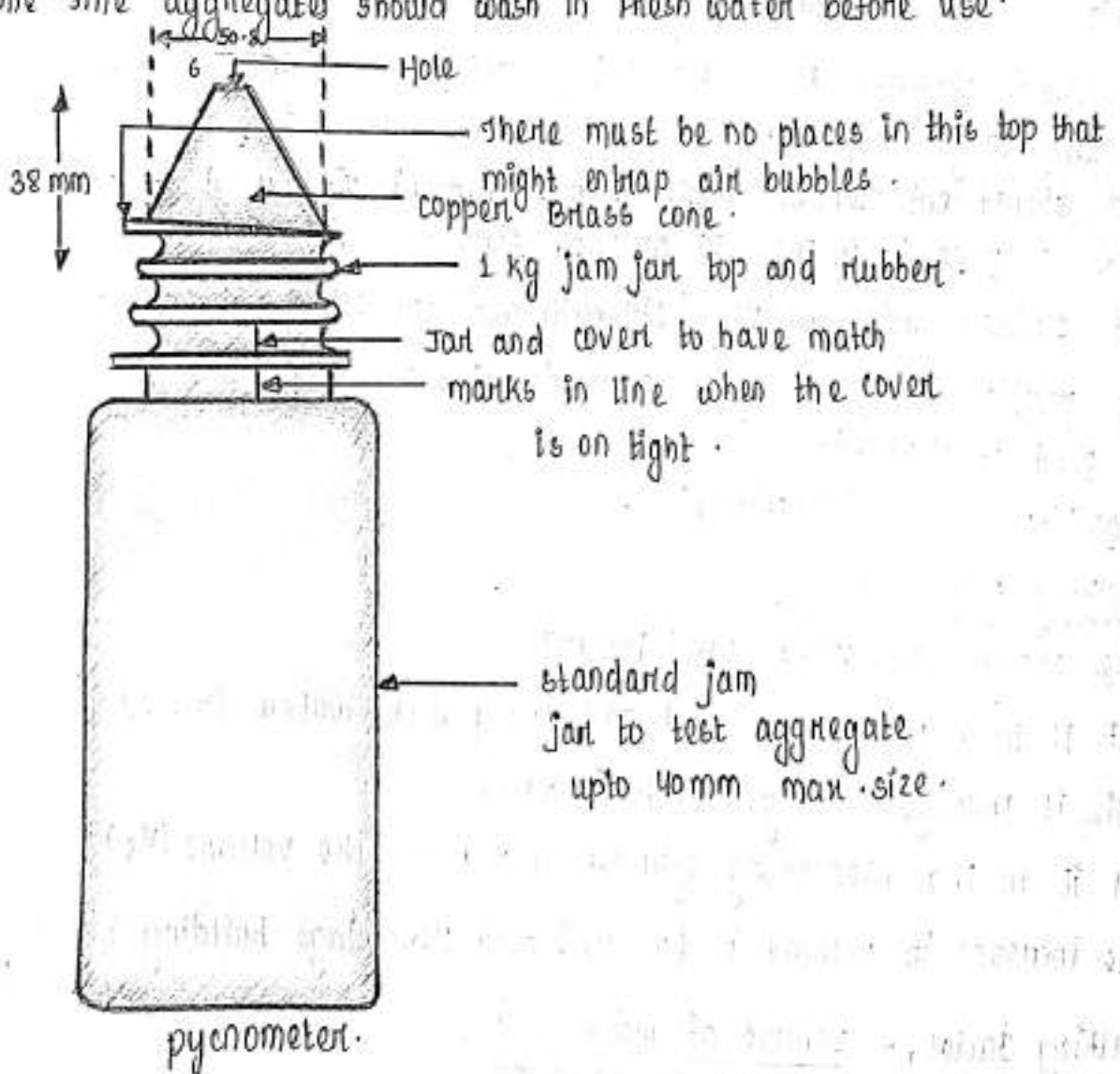

## Bricks Masonry.

The bricks are obtained by moulding clay in rectangular blocks of uniform size and then by drying and burning these blocks.

They are light in weight and no lifting appliance is required for them.

The bricks do not require dressing but stone require dressing before use in construction.

The actual size, Nominal size and traditional brick sizes are.

Actual size - 19cm x 9cm x 9cm or 10" x 5" x 3"

Nominal size - 20cm x 10cm x 10cm

Traditional size - 9" x 4 1/2" x 3".

The average weight of a brick is 3 to 3.50 kg.

## Some definitions.

Stretcher - This is a brick laid with its length parallel to the face or front or direction of a wall. The course containing stretchers is called a stretcher course.

Header - This is a brick laid with its breadth or width parallel to the face or front or direction of a wall. The course containing headers is called header course.

Joints - The edges formed by the intersection of plane surfaces of brick are called the joints and they should be sharp, square and free from damage.

Bed - The lower surface of the brick, when laid flat is known as the bed.

Bed joint - The horizontal layer of mortar upon which the bricks are laid is known as a bed joint.

Perpends - The vertical joints separately the bricks in either length or cross direction are known as the perpends and for a good bond, the perpends in alternate courses should be vertically one above the other.

7. Lap - The horizontal distance between the vertical joints in successive courses is known as a lap and for a good bond, it should be one-fourth of the length of a brick.
8. Closer - A piece of brick which is used to close up the bonds at the end of brick courses is known as a closer and it helps in preventing the joints of structure courses to come in a vertical line. It is not specially moulded but it is prepared by the mason with the edge of the trowel. The following are the types of closer:
- i) Queen closer - This is obtained by cutting the brick longitudinally in two equal parts. It can also be made from two quarter bricks, known as the quarter closers to minimise the wastage of brick. A queen closer is generally placed near the quoin header to obtain the necessary lap.
  - ii) King closer - This is obtained by cutting a triangular portion of the brick such that half a header and half a stretcher are obtained on the adjoining cut faces. A king closer is used near door and window openings to get satisfactory arrangement of the mortar joint.
  - iii) Bevelled closer - This is obtained by cutting a triangular portion of the ~~brick~~ half the width but of full the length. A bevelled closer appears as a closer on one face and a header at the other face. It is used for the splayed brick works.
  - iv) Mitred closer - This is obtained by cutting a triangular portion of the brick through its width and making an angle of  $45^\circ$  to  $60^\circ$  with the length of the brick. It is used at corners, junctions, etc.
9. Bat - This is a piece of brick and considered to the length of a brick and known as half bat, or three-quarter bat, bevelled bat.



Bull nose - A brick moulded with a rounded angle is known as bull nose. A connection which is and bullnose brick is used. The centre of the curved portion is situated on the long centre line of the brick.

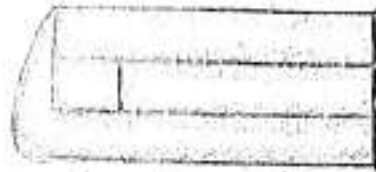

Cownose - A brick moulded with a double bull nose one end is known as cownose.

Squint quoin - A brick which is cut or moulded such that an angle other than a right angle is formed is known as a squint quoin.

Frog - A frog is a mark of depth about 10 mm to 20 mm which is placed on the face of a brick to form a key for holding the mortar.

Ranking back - The termination of a wall in a stepped fashion is known as ranking back.

Teething - The termination of a wall in such a fashion that each alternate course at the end projects is known as the teething and it is adopted to provide adequate bond, when the wall is continued horizontally at a later stage.

Rules to be observed for getting a good bond are as follows:

- i) The amount of lap should be minimum one-fourth brick along the length of the wall and one-half brick across the thickness of the wall.
- ii) The bricks should be uniform size to get uniform lap.
- iii) The stretchers should be used in the facing. The hearting should be used in the ~~face~~ headers only.
- iv) The use of brick bats should be discouraged except under special circumstances.
- v) The vertical joints in the alternate courses should be along the same perpend.

The various types of bond and with their patented names have been constructed. Following are the types of bonds in brickwork.

1. Stretcher bond.
2. Header bond.
3. English bond.
4. Flemish bond.
5. Garden-wall bond.
6. Raking bond.
7. Dutch bond.
8. Brick-on-edge bond.
9. English cross bond.
10. Facing bond.

### Building Material

#### Use of Flyash as Building Material and Road Construction

- i. Flyash can be used as brick due to certain advantages over the conventional red bricks.
  - i) uniform and standard product size resulting in 10% less consumption of bricks per unit construction.
  - ii) cement consumption is less in cement and mortar.
  - iii) compressive strength is more than conventional red bricks ( $> 100 \text{ kg/cm}^2$ ) and further increase with the passage of time.
  - iv) less load on foundation due to light weight.
  - v) due to the property of less water absorption and no weathering effects, surfaces can be left exposed without plastering and direct application of paint is also possible.
2. Flyash can be used for manufacturing of (ppc) cement (portland pozzolana cement).
 

When highly reactive flyash is mixed with portland cement clinker and ground with 5-6% of gypsum the resultant is portland pozzolana cement (ppc). It contains 45% of flyash. It has lower heat of hydration and gives sulphate resistant, lower shrinkage, used all types of construction.

Flyash can be used for sintered light weight aggregates and cellular light weight aggregates.

The production of (SLWA) is done by using dry flyash, mixing with water with the addition of high corrosion flyash or carbon.

The production of (CLWA) is done by using flyash, cement coarse sand, fine sand and a foaming agent in a mixture to form a thin slurry.

This slurry is then poured in moulds and allowed to set. The blocks are then removed from the moulds and are cured by spraying water on the stack. The blocks are specially useful in high rise construction reducing the deadweight of the structure.

Flyash can be used for road embankment and stabilization of sub base course.

The most distinguishing features of a flyash embankment would be use of flyash as core-material with earth cover.

Intermediate soil layer of thickness 200 to 400 mm are usually provided when height of embankment exceed 3m.

These intermediate soil layers provide flyash embankment from erosion due to rain and wind. If the embankment should be protected by providing earth cover.

Sub base course can be constructed using ash replacing conventionally used mortum.

Flyash is cohesionless and non-plastic in nature.

Mortum and Gravel used as in Road construction and building material

Natural soils, sands, gravel material and mortum are frequently used as sub-base material for road construction.

Now a days crushed stone and crusher dust mixes as sub-base and base courses in road construction.

NOTE

- i) Flyash can be used to replace a portion of cement in concrete.
- ii) In concrete floor a mixture of cement, sand, gravel can be used.
- iii) Mortar flooring can be adopted in kutchra flooring in village house.

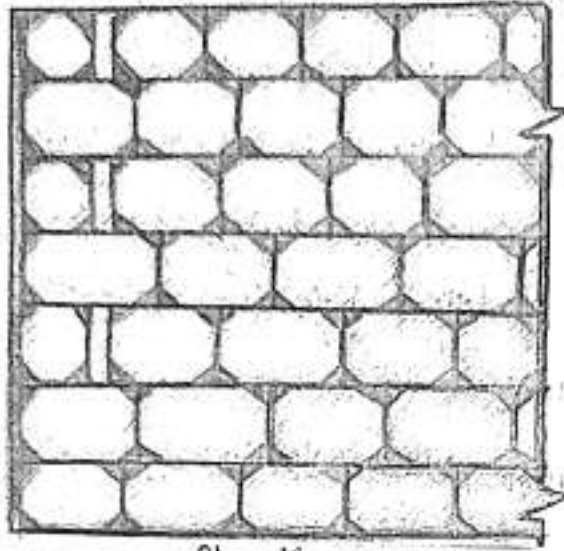

Elevation

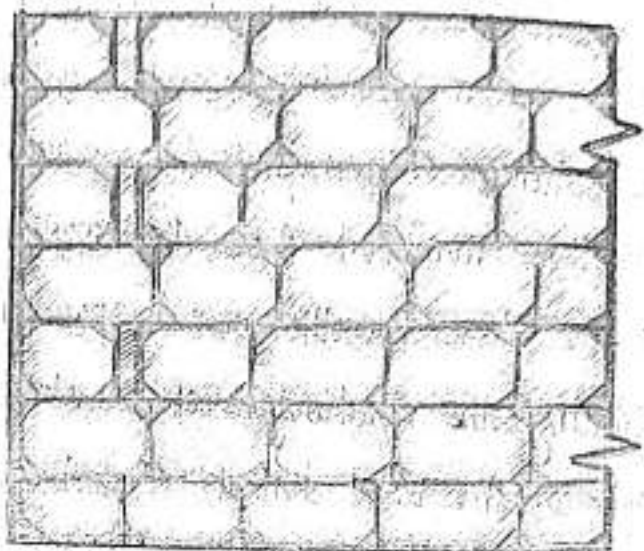

Elevation

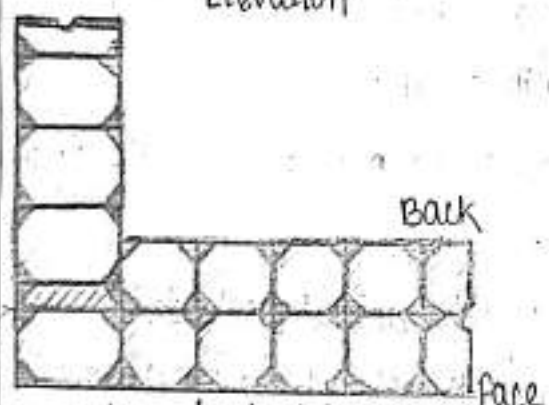

plan of stretch course

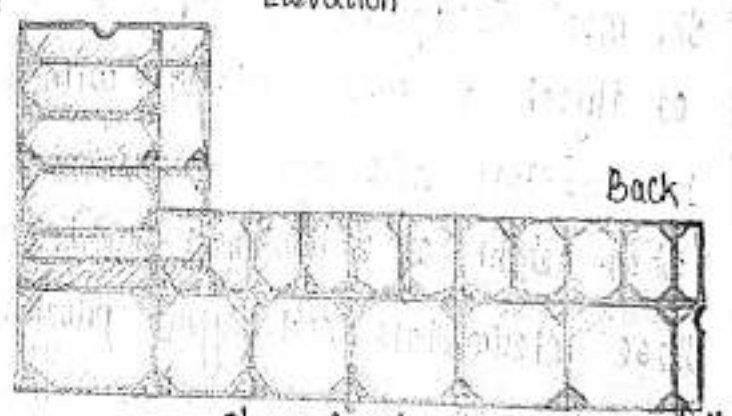

plan of stretch course

Queen closer

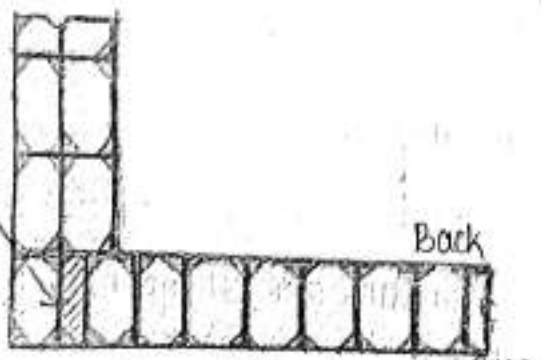

plan of header course

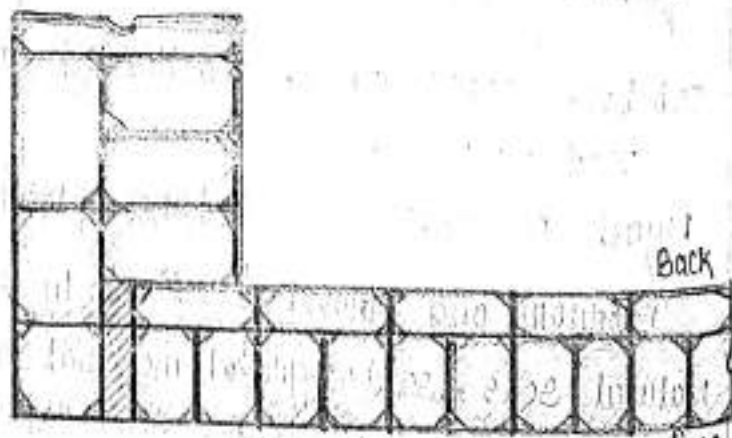

plan of header course

English bond - I brick wall.

English bond - 1 1/2 brick wall.

60

If the wall thickness is an even multiple of half-brick the same course shows header or stretchers in both the front and the back elevations. But if the wall thickness is an uneven multiple of half-brick, a course showing stretchers on the face, shows headers on the back and vice versa.

The bricks in the same course do not break joints with each other. The joints are straight.

In this bond, the continuous vertical joints are not formed except at certain stopped ends.

The number of mortar joints in the header course is nearly double than that in the stretch course so care should be taken to make the header joints thinner, otherwise the face lap disappears quickly.

A header course should never start with a queen closer as it is liable to get displaced in this portion.

The queen closers are not required in the stretched courses.

In the stretch course, the stretchers have a minimum lap of one-fourth of their length over the headers.

For walls having thickness of two bricks or more, the bricks are laid as stretchers or headers only on the face courses of the wall. The interior filling is done entirely with the headers.

# Construction Technology

## Bonds at connections

### Definition

The walls in different directions are to be united at certain places. These places are known as the connections.

### Three requirements to be satisfied by bond at a connection

- i) The vertical joints should not be continuous.
- ii) The number of broken bricks to be used should be reduced to a minimum.
- iii) The connection should be structurally strong enough to resist the differential settlement.

There are two forms of connections

- 1) Junctions.
- 2) Quoins.

1) Junctions: A connection between a main wall and a partition wall is termed as a junction.

Following points should be kept in view while providing a junction.

- i) The header course of the cross wall enters the stretcher course of the main wall.
  - ii) The alternate courses of the cross wall are simply abutting the main wall.
- A junction is classified in two categories:
- i) Right-angled junction.
  - ii) Squint junction.

### i) Right-angled junction

This type of junction has two forms.

- i) See-junction.
- ii) Cross junction or intersection.

1) See-junction - This type of right-angled junction forms the shape of the English letter T in plan.

Cross-junction or Intersection - When two continuous walls cross or intersect each other, a cross-junction or an intersection is formed.

Note

The alternate courses of the crosswalls i.e. the courses of one of the walls simply butt against the courses of the other wall.

The alternate courses which are not continuous are provided with tie bricks in the form of key headers to create the necessary bond and lap.

Squint Junction

A squint junction is formed when two walls meet each other at an angle other than a right angle without making a quoin.

It may be in the English bond or Flemish bond.

Squint junction is rarely adopted in brick masonry construction.

Quoins - A connection which is formed when a wall takes a turn is known as a quoin. There are two forms of quoins.

- i) Right angled or square quoins
- ii) Squint quoins.

Right angled or square quoins

This form of quoin is formed when two walls meet at an angle of  $90^\circ$ .

Squint quoins

When a wall takes a turn and makes an angle other than a right-angle, a squint quoin is formed.

Squint quoins is divided into two types.

- a) A acute squint
- b) obtuse squint

Acute squint - In this case, the enclosed angle on the inside of the wall is less than a right angle.

Obtuse squint - In this case, the enclosed angle on the inside of the wall is between  $90^\circ$  and  $180^\circ$ .

concreteWater cement Ratio.

- i) The quantity of water added to cement while preparing concrete mixes has been known to exert tremendous influence on the quality of concrete.
- ii) It was first discovered in 1918, when D. F. Abraham evaluated this aspect of concrete proportioning and stated:  
For all plastic mixes using sound aggregates, strength and other desirable properties of concrete under given job conditions are governed by the net quantity of water used per sack of cement.  
Water performs two essential functions in concrete.
- i) It hydrates the cement which is an essential chemical reaction for formation of complex silicate crystalline gel that are responsible for the strength of the cement.
- ii) It lubricates all the concrete ingredients by passing around them in the form of films so it is responsible for the plasticity and mobility of concrete which define its workability.
- iii) After experimental investigation, it is established that ordinary portland cement requires part (by weight) of cement to 0.25 parts (by weight) of water for complete hydration setting and hardening for lubrication and workability of the mix, additional water must be added. This additional water varies from 0.15 to 0.45 percent by weight of cement and ~~has~~ has to be determined with great caution.
- iv) This additional lubrication water, evaporates after the concrete is placed and also released during compaction. Both these processes (of ~~escape~~ escape of additional water) result in voids in the concrete.



- 5) These voids reduces the strength of the concrete on setting.
- 6) So keep the ratio of water to cement as low as possible to obtain a strong, dense concrete.
- 7) Any extra amount of water is added to concrete ingredients at the time of mixing also favours segregation of aggregates during transport and placement.
- 8) In figure for a given type of cement, aggregates of same type and size and same methods of mixing the concrete develops a maximum compressive strength of  $380 \text{ kg/cm}^2$  at a  $w/c = 0.4$   $w = c \times 0.4$   $c = \text{cement}$   
ml of water.
- 9) When this ratio is increased to 0.5, 0.6 and 0.7, the resulting batches of concrete show considerably less compressive strength.

### Workability.

The workability is defined as the ease with which concrete may be mixed, handled, transported, placed in position and compacted. A workable concrete does not show any bleeding or segregation.

### Factors Affecting workability of concrete.

Workability of concrete mix depends upon the number of factors. These factors are listed below.

Water content  $\div$  Water content mix plays a significant role in workability. With increase in water content, the workability of mix also increases ~~in water content~~, ~~but~~ but excess of water in a mix results in low compressive strength and lesser durability.

Size of Aggregates  $\div$  For the same volume of aggregates in concrete, the use of coarse aggregate of larger size gives higher workability. Therefore, lesser quantity of water used in large size particles reduces the quantity of cement for given w/c ratio and is considered as economical.

3. Shape of Aggregates ÷ shape of aggregates plays a vital role in workability of concrete. Round and smooth aggregate gives higher workability where as angular and rough surface aggregates have lesser workability.
4. Temperature ÷ The workability of a concrete mix is affected with change in temperature. On a hot dry, it becomes necessary to increase the water content of mix in order to maintain the desired workability.
5. Effect of time ÷ The freshly prepared concrete mix loses workability with time mainly because of the loss of moisture due to evaporation.
6. Grading of aggregates ÷ Generally the mixes with higher w/c ratio would require some what finer grading and mixes with low w/c ratio a coarser grading of aggregates is preferable.
7. Admixtures ÷ Certain admixtures are added in concrete mix to increase the workability such as air entraining agents which produce air bubbles.

#### Test of workability.

1. Slump cone test.
2. Compaction factor test.
3. Vee-bee test.

Three type of slumps have been observed to occur.

- a) True slump - where sliding is equal through out the cone.
- b) Shear slump - where one half from the top falls by shear and slides to one side reduction in height is different in different direction.
- c) Collapse slump - This occurs in concrete of high water content, the material almost flows unequally in all direction.